

Signing and Marking Design Guidelines



8/9/2024
Revision 6.4
Atlanta, GA 30308

This document was developed as part of the continuing effort to provide guidance within the Georgia Department of Transportation in fulfilling its mission to provide a safe, efficient, and sustainable transportation system through dedicated teamwork and responsible leadership supporting economic development, environmental sensitivity and improved quality of life. This document is not intended to establish policy within the Department, but to provide guidance in adhering to the policies of the Department.

Your comments, suggestions, and ideas for improvements are welcomed.

Please send comments to:

State Design Policy Engineer
Georgia Department of Transportation
One Georgia Center
600 West Peachtree Street, N.W., 26th Floor
Atlanta, Georgia 30308

DISCLAIMER

The Georgia Department of Transportation maintains this printable document and is solely responsible for ensuring that it is equivalent to the approved Department guidelines.

Revision History

Revision Number	Revision Date	Revision Summary
2.0	11/2008	All - Revised and Combined Interstate and Limited Access Roadway Signing and Marking Design Guidelines and Non-Interstate Signing and Marking Design Guidelines
2.1	1/2011	<p style="text-align: center;">All - Revised Figures</p> <p style="text-align: center;">Chapter 2 - Removed section 2.6 Detail Estimate</p> <p style="text-align: center;">Chapter 3 - Added Bicycle Warning and Share the Road Sign Guidance and Revised Figures Specified 36" for Warning Signs on State Routes</p> <p style="text-align: center;">Appendix A - Revised Legend and Figures</p>
3.0	12/2013	All – Major Revision
3.1	10/2015	<p style="text-align: center;">Section 2.4 - Changed General Notes location.</p> <p style="text-align: center;">Section 2.5 - Changed the Reflective Sheeting</p> <p style="text-align: center;">Section 3.1- Removed pavement marking plans</p> <p style="text-align: center;">Section 3.1.2 - Changed “or” to “and/or”.</p> <p style="text-align: center;">Section 3.1.4 - Removed Type 3 sentence</p> <p style="text-align: center;">Section 3.2 - Change Type 9 to Type 11</p> <p style="text-align: center;">Section 3.2.2 - Changed “or” to “and/or”.</p> <p style="text-align: center;">Section 3.2.6 - Added last sentence.</p> <p style="text-align: center;">Section 3.2.7 - Added “on median divided roadways”</p> <p style="text-align: center;">Section 3.2.8 - Remove “four-lane” from first sentence.</p> <p style="text-align: center;">Section 3.3 - Changed Type 9 to Type 11. Added “a minimum of” to last sentence. Added sub-sections 3.3.1, 3.3.2, 3.3.3, 3.3.4 & 3.3.5</p> <p style="text-align: center;">Section 3.3.3 - Add types of advance warning signs. Added Table 2C-2.</p> <p style="text-align: center;">Section 3.3.5 - For criteria: removed “or more”.</p> <p style="text-align: center;">Section 3.4.2 - Removed and adjusted section numbers.</p> <p style="text-align: center;">Section 3.5 - Changed reflective sheeting.</p> <p style="text-align: center;">Section 3.6 - Change sign blank for overhead street name signs & letter size. Reworded “Typical sign installation.....” paragraph.</p> <p style="text-align: center;">Section 4.1 - 5th paragraph – removed last sentence.</p> <p style="text-align: center;">Section 6.1 - Removed sign post redundancy</p> <p style="text-align: center;">Section 7.0 - Change Title.</p> <p style="text-align: center;">Section 7.1 - Revised Table 7-1.</p> <p style="text-align: center;">Section 8.1 - 3rd paragraph, changed last sentence from 1 foot to 2 foot.</p> <p style="text-align: center;">Section 8.2 - 2nd paragraph, last sentence, removed “on one of</p>

		<p>the.....sheets”</p> <p>Section 10.2 - 2nd paragraph, 2nd sentence – changed should to shall.</p> <p>Section 11.1 - Last paragraph – replaced “will need to” with “shall contact” and corrected contact numbers.</p> <p>Section 12.1 - 1st paragraph, 3rd sentence – replaced should with shall.</p> <p>Section 12.1.1 - Added asterisk and remove numeral width.</p> <p>Section 12.2.2 - Changed from “paint” to “see table” and added Type 1 & Type 4 as Hot Applied Preformed Thermoplastic or Contrast Preformed Plastic.</p> <p>Section 12.2.3 - Added reference to Table 12-1 and page 12-4.</p> <p>Section 12.2.4 - Added explanation of how striping is paid for.</p> <p>Section 12.2.5 - Added T-12A.</p> <p>Section 12.2.6 - Added T-12A.</p> <p>Section 12.3 - Added T-15A, 15B & 15C.</p> <p>Section 13.2.1 - Removed reference to RA-3 Detail and added guidance for MUTCD information.</p> <p>Section 13.2.2 - Revised 2nd sentence.</p> <p>Section 13.2.4 - Revised paragraph to include W11-2, R4-7 & R6-4.</p> <p>Section 13.3.1 - Revised width of yield bar on concrete.</p> <p>Section 13.3.2 - Added Construction Detail T-12C.</p> <p>Section 13.3.3 - Added Construction Detail T-12C.</p> <p>Section 13.4 - Roundabout Definitions were removed. Refer to NCHRP 672.</p> <p>Appendix A - Completely revised to be in line with 2009 MUTCD</p> <p>Appendix B - Fig. B-11 thru B-16 & B-19 revised location of RPM’s.</p> <p>Appendix C - Add Note #7. Remove “paint” references.</p> <p>Appendix E - Revised reflective sheeting.</p> <p>Appendix F - Revised fig. 10-1, 10-2 & 10-3 under Design Data added “Maximum Loading”.</p>
<p>4.0</p>	<p>9/22/16</p>	<p>Converted to standard template</p>
<p>5.0</p>	<p>5/8/18</p>	<p>Section 2.3.1.2 – Revised text to include “RPM”</p> <p>Section 2.4 – Changed “Signing and Marking Plans” to “Plans”</p> <p>Section 3.1 – Reworded text regarding four-lane and five-lane roads, added text regarding the standard size of signage</p> <p>Section 3.3.3 – Changed six-inch lettering to four-inch lettering for conventional W16-8 and six inch lettering for expressway signage.</p>

		<p>Section 3.3.5 – Revised paragraph to recommend the use of “Bikes May Use Full Lane Signs (R4-11)”. Removed sign location criteria</p> <p>Section 3.3.6 – Added subsection to discuss R4-11 signs</p> <p>Section 3.4.1.2 – Revised guidance for Mile Post signing</p> <p>Section 3.4.5 – Add guidance on the design of PIOH signs</p> <p>Section 3.4.6 – Removed guidance on usage of fonts. Included guidance on spacing of text.</p> <p>Chapter 4 – Revised title to read “Location and Sequence of Signs (Interstate/Freeway)”</p> <p>Removed “Miscellaneous Signs” subsection</p> <p>Section 4.1 – Reworded the paragraph regarding the order of destinations on guide signs</p> <p>Section 4.3 – Revised the placement of mile post signs</p> <p>Section 5.3 – Replaced R553-7 with R3-8</p> <p>Section 5.4 – Replaced R553-7 with R3-8</p> <p>Section 5.6 – Added subsection for Lane Drop – Drop Option Auxiliary Lane</p> <p>Section 6.1 – Changed text in the fourth paragraph to read “...retro-reflectivity sheeting and latest design layout is used.”</p> <p>Section 8.2 – Changed Item No. 636-1077 to 636-1045 and corrected the extruded panel signs to TP 11 sheeting</p> <p>Section 9.2 – Change Item No. 636-1077 to 636-1045 and changed the reflective sheeting to TP 11</p> <p>Section 10.1 – Changed text to read “Sign height measurements shall be in 6-inch increments and width measurements shall be in 1-inch increments.</p> <p>Section 12.1 – changed text to read “however, other materials with contrast...”</p> <p>Section 12.1.1 – revised Pavement Marking Selection Chart</p> <p>Section 12.2.2 – Removed “Pavement Marking Selection Chart” from text and changed Detail from R-13 to T-16. Removed “...for Asphalt or Preformed Plastic with Contrast for Concrete”</p> <p>Section 12.2.3 – Revised entire section.</p> <p>Appendix A – Revised Figures</p> <p>Appendix B – Revised Figures B-5 and B-8, Removed Figures B-6 and B-7.</p> <p>Appendix E – Revised Figure E-2</p> <p>Appendix F – Revised Figures 3-4, 5-2, 5-3, 5-4</p>
5.1	9/18/18	Updated GDOT logo throughout
5.2	11/29/18	<p>Cover Sheet – Changed picture</p> <p>Chapter 8 – Changed pay item number from 636-1045 to 636-</p>

		<p>1077</p> <p>Chapter 9 – Changed pay item number from 636-1045 to 636-1080 and 636-1081</p> <p>Added Table 12-2 for Pavement Marking Types</p> <p>Revised Chapter 13: Roundabout Signing and Marking</p> <p>Appendix B – Revised Figures B-2, B-4, B-5, B-12 and B-16</p> <p>Appendix E – Revised Page E-3</p>
5.3	1/8/20	<p>Appendix E - Note 4C of the General Notes for Standard signs has been updated to read as follows: When guardrail is present or being proposed, signs shall be posted an unstipulated distance behind guardrail.</p>
6.0	10/29/20	<p>Updated GDOT branding throughout</p> <p>Updated revision number to 6.0 throughout since some of the sections were not updated properly in past revisions</p> <p>Chapter 3 – Added subsection for R5-10A signs</p> <p>Chapter 12 – Updated Pavement Marking Selection Chart. Updated Table 12-2: Pavement Marking Types</p> <p>Chapter 13 – Updated text within subsection 13.2.2. Updated text within subsection 13.2.3</p> <p>Appendix B – Updated Figures B-3, B-4 and B-18</p> <p>Appendix E – Updated General Notes for Special Roadside Signs and Overhead Highway signs</p> <p>Appendix F – Added Figure 4-7, depicting R559-1 sign (TO CIRCULATING TRAFFIC)</p>
6.1	8/10/21	<p>Chapter 3 – Removed “and/” from Type 2 material reference</p>
6.2	8/25/23	<p>Chapter 1 – Updated GDOT hyperlinks</p> <p>Chapter 2 – Updated GDOT hyperlinks. Revised section 2.4 to reference appendices</p> <p>Chapter 3 – Various formatting changes and figure relocation. Added additional info on road name plaques</p> <p>Chapter 4 - Revised guidance for Champion Signs. Revised guidance for placement of W8-13 signs. Revised figure reference in appendix for section 4.15</p> <p>Chapter 5 - Various formatting changes and figure relocation. Added new figure 5-3C for conventional lane drop signing and marking</p> <p>Chapter 7 - Added D1-5 signs to Table 7-1</p> <p>Chapter 8 – Updated GDOT hyperlinks</p> <p>Chapter 11 – Updated GDOT hyperlinks</p>

		<p>Chapter 12 - Various formatting changes. Revised Pavement Marking Selection Chart. Removed link to crosswalk guidance. Revised 12.2.8 to reference revised Chapter 5 guidance. Added additional context to sections 12.4 and 12.4.2 to reference the Ped. & Streetscape Guide and the GDOT DPM, respectively.</p> <p>Chapter 13 - Various formatting changes. Added NCHRP 1043 to section 13.1. Revised 13.2.3.b. Revised 13.2.4. Revised 13.2.5. Revised 13.3.1 to align with current GDOT RAID Team and RBDG preference</p> <p>Appendix B - Minor updates to figure/image resolution</p> <p>Appendix C - Revised detail reference for shoulder rumble strip in note 4 of figure C-2.</p> <p>Appendix E - Minor updates to figure/image resolution</p> <p>Appendix F - Added Fig. 4-8, removed Figs. 7-1 & 7-2. Revised Fig. 9-1</p>
6.3	6/12/24	<p>Chapter 3 – Added section to clarify required signing and marking at “T” intersections based on the 2009 MUTCD.</p> <p>Appendix F – Added figure 3-10 to clarify required signing and marking at “T” intersections based on the 2009 MUTCD.</p>
6.4	8/9/24	<p>Appendix E – ‘General Notes – Standard Signs’ to include discussion of DO NOT ENTER sign mounting height at ramps, and required horizontal clearance for signs in or adjacent to sidewalk.</p>

Intentionally Left Blank

List of Effective Chapters

Document	Revision Number	Revision Date
List of Effective Chapters	6.4	8/9/24
Table of Contents	6.4	8/9/24
Chapter 1. Introduction	6.1	8/25/23
Chapter 2. General Information	6.1	8/25/23
Chapter 3. Sign Design Standards	6.3	6/12/24
Chapter 4. Location and Sequence of Signs (Interstate/Limited Access)	6.1	8/25/23
Chapter 5. Specific Sign Sequencing for Particular Applications	6.1	8/25/23
Chapter 6. Standard Signs	6.1	8/25/23
Chapter 7. Sign Layouts for Special Roadside and Overhead Highway Signs	6.1	8/25/23
Chapter 8. Special Roadside Signs Interstates/Freeways	6.1	8/25/23
Chapter 9. Overhead Highway Signs/Structures	6.0	10/29/20
Chapter 10. Clearance Diagrams for Overhead Signs	6.0	10/29/20
Chapter 11. Specific Service Signs (Logo Signs)	6.1	8/25/23
Chapter 12. Pavement Marking Designs Standards	6.1	8/25/23
Chapter 13. Roundabout Signing and Marking	6.1	8/25/23
Appendix A. Index and Legend	6.0	10/29/20
Appendix B. Typical Signing and Pavement Marking	6.1	8/25/23
Appendix C. Bicycle Signing and Marking	6.1	8/25/23
Appendix D. Summary of Quantities	6.0	10/29/20
Appendix E. General Notes	6.2	8/9/24
Appendix F. Figures	6.2	6/12/24

Intentionally Left Blank

Table of Contents

Revision History	i
List of Effective Chapters	vii
Table of Contents.....	ix
Chapter 1. Introduction - Contents	1-i
1.1 Definitions	1-1
1.2 Applicable Standards and Specifications	1-2
Chapter 2. General Information - Contents.....	2-i
2.1 Drafting Standards.....	2-1
2.2 Electronic File Structure	2-1
2.2.1 Cell Libraries	2-1
2.3 Signing and Marking Plan Sheets	2-1
2.3.1 Required Information	2-1
2.3.2 Sheet Layout	2-2
2.4 General Notes	2-2
2.5 Summary of Quantities Sheets.....	2-2
2.6 Sign Detail Sheets	2-3
2.7 Clearance Diagrams.....	2-3
Chapter 3. Sign Design Standards - Contents.....	3-i
3.1 General Sign Guidelines.....	3-1
3.2 Regulatory Signs	3-1
3.2.1 Stop Signs (R1-1).....	3-1
3.2.2 Yield Signs (R1-2)	3-1
3.2.3 Speed Limit Signs (R2-1)	3-2
3.2.4 Right (Left) Lane Must Turn Right Signs (R3-7).....	3-2
3.2.5 Keep Right Signs (R4-7)	3-2
3.2.6 Do Not Enter Signs (R5-1)	3-2
3.2.7 Wrong Way Signs (R5-1a)	3-2
3.2.8 Divided Highway Crossing Signs (R6-3)	3-2
3.2.9 State Line Signing	3-3
3.2.10 Selective Exclusion Signs (R5-10a)	3-3
3.3 Warning Signs	3-3
3.3.1 W3-1 and W3-3	3-3
3.3.2 W3-5.....	3-3
3.3.3 Road Name Signs Used in Conjunction with Warning Signs (W16-8)	3-3
3.3.4 Bicycle Warning Signs (W11-1).....	3-4

- 3.3.5 Share the Road Signs (W16-1)3-5
- 3.3.6 Bikes May Use Full Lane Signs (R4-11)3-5
- 3.3.7 Required Signs at “T” Intersections and Road Ends3-5
- 3.4 Guide Signs3-6
 - 3.4.1 Route Markers3-6
 - 3.4.2 Political Boundary Signs3-6
 - 3.4.3 Directional Signs for Recreation and Cultural Interest Areas3-6
 - 3.4.4 Tourist-Info Visitor Center3-7
 - 3.4.5 Public Interest Open House (PIOH) Signs3-7
 - 3.4.6 Lettering Guidelines3-7
- 3.5 School Zone and Pedestrian Crossing Signs3-7
- 3.6 Overhead Signs3-8
- 3.7 Sign Posts3-9
 - 3.7.1 Description3-9
 - 3.7.2 Wind Loads3-9
- Chapter 4. Location and Sequence of Signs (Interstate/Freeway) - Contents..... 4-i
 - 4.1 Exit Signing.....4-1
 - 4.2 Post-Interchange Sequence Signing4-2
 - 4.3 Mile Post Signs.....4-3
 - 4.4 Political Boundary Signs4-3
 - 4.4.1 Specialty Signs for Champion Signs4-3
 - 4.5 Waterway Signs.....4-3
 - 4.6 Hospital Signs.....4-3
 - 4.7 Bridge Caution Signs.....4-4
 - 4.8 No Trucks Over 6 Wheels Allowed in Left X Lanes Signs4-4
 - 4.9 Truck Use I-2854-4
 - 4.10 Emergency Parking Only Signs4-4
 - 4.11 Up to \$1,200 Fine for Throwing Trash on Highway Signs4-4
 - 4.12 Slower Traffic Keep Right Signs4-4
 - 4.13 Keep Off Median Signs.....4-4
 - 4.14 Reduced Speed Ahead Signs4-4
 - 4.15 Overhead Regulatory Signs4-4
- Chapter 5. Specific Sign Sequencing for Particular Applications - Contents5-i
 - 5.1 Lane Reduction for Interstates5-1
 - 5.2 Lane Reduction for Conventional Roads5-2
 - 5.3 Lane Reduction for Conventional Roads5-2
 - 5.4 Lane Drop – Continuous to Exit Lane.....5-4

5.5 Lane Drop – Auxiliary Lane5-5

5.6 Lane Drop – Drop Option5-6

5.7 Lane Drop – Drop Option Auxiliary Lane5-6

Chapter 6. Standard Signs - Contents6-i

6.1 General.....6-1

Chapter 7. Sign Layouts for Special Roadside and Overhead Highway Signs - Contents7-i

7.1 General.....7-1

Chapter 8. Special Roadside Signs Interstates/Freeways - Contents8-i

8.1 General.....8-1

8.2 Placement.....8-3

Chapter 9. Overhead Highway Signs/Structures - Contents.....9-i

9.1 General.....9-1

9.2 Placement.....9-1

Chapter 10. Clearance Diagrams for Overhead Signs - Contents10-i

10.1 General.....10-1

10.2 Design Elements10-1

Chapter 11. Specific Service Signs (Logo Signs) - Contents.....11-i

11.1 General.....11-1

Chapter 12. Pavement Marking Designs Standards - Contents12-i

12.1 Materials12-1

12.1.1 Pavement Marking Selection Chart.....12-1

12.2 Pavement Markings.....12-2

12.2.1 Edge lines.....12-2

12.2.2 Bicycle Lanes12-2

12.2.3 Crosswalks12-2

12.2.4 Borders.....12-2

12.2.5 Pavement Marking “ONLY”12-2

12.2.6 Pavement Marking Arrows12-3

12.2.7 Pavement Marking Shields.....12-3

12.2.8 Lane Drop Striping12-3

12.3 Raised Pavement Markers12-3

12.4 Guidance on Marking Crosswalks12-3

12.4.1 Controlled Intersections:.....12-3

12.4.2 Uncontrolled Intersections:.....12-4

Chapter 13. Roundabout Signing and Marking - Contents13-i

13.1 General.....13-1

13.2 Signing.....13-1

- 13.2.1 Advanced Warning Signs13-1
- 13.2.2 Yield Sign13-1
- 13.2.3 Guide Signs13-1
- 13.2.4 Lane Use Signs13-2
- 13.2.5 Other Signs13-2
- 13.3 Marking13-2
 - 13.3.1 Edge Line Extension13-2
 - 13.3.2 Lane Use13-2
 - 13.3.3 Multilane Pavement Markings13-2
 - 13.3.4 Pedestrian Crossings13-3
 - 13.3.5 Rumble Strips13-3
 - 13.3.6 Marking Materials13-3
 - 13.3.7 Guidance on Marking Crosswalks13-3
- Appendix A. Index and LegendA-1
- Appendix B. Typical Signing and Pavement MarkingB-1
- Appendix C. Bicycle Signing and MarkingC-1
- Appendix D. Summary of QuantitiesD-1
- Appendix E. General NotesE-1
- Appendix F. FiguresF-1

Chapter 1. Introduction - Contents

Chapter 1. Introduction - Contents	1-i
1.1 Definitions	1-1
1.2 Applicable Standards and Specifications	1-2

Chapter 1. Introduction

These design guidelines provide standards, guidelines, and specifications that will be used for the design of traffic signing and pavement markings prepared for the Georgia Department of Transportation (GDOT). These design guidelines include a compilation of specific drafting and design standards, plan and specification presentations, and review procedures to ensure that construction documents properly convey the extent and character of work to be performed. Sound traffic engineering judgment shall be exercised in applying these guidelines. Along with the companion document on traffic signal design, these documents contain comprehensive guidelines intended to provide consistency in plans for traffic control devices.

This document replaces previous editions of Non-Interstate Signing and Marking Design Guidelines and Interstate and Limited Access Roadway Signing and Marking Design Guidelines.

1.1 Definitions

AASHTO “Green Book” – A Policy on Geometric Design of Highways and Streets as published by the American Association of State Highway and Transportation Officials (AASHTO), latest edition adopted by GDOT. Design standards outlined in this publication shall govern most geometric considerations. This publication provides guidance on the physical design of highways and streets.

Conventional Road – A street or highway other than a freeway, expressway or special purpose road.

Entrance ramp end – The point, as defined in the AASHTO “Green Book,” where the full width of the ramp entering a facility becomes less than the full lane width.

Guide signs – Show route designations, destinations, directions, distances, services, points of interest, and other geographical, recreational, or cultural information.

Interstate – A freeway (divided highway with full control of access).

MUTCD – Manual on Uniform Traffic Control Devices – Approved by the Federal Highway Administration as the national standard for the placement and standardization of all signs, signals, and markings placed on public facilities.

Non-Interstate – An expressway (a divided highway with partial control of access).

Overhead signs – Signs that are manufactured using extruded aluminum panels and are mounted over the roadway facility.

- *Type I, bridge overhead sign structure* – A horizontal structure that spans the roadway and is supported at each end by columns.
- *Type II, cantilever overhead sign structure* – A horizontal structure that is supported at one end by a single column. No new Type II structures shall be installed.
- *Type III, butterfly overhead sign structure* – A horizontal structure that extends in opposite directions from a single column support.
- *Type IV, combination overhead sign structure* – A horizontal structure with two supports, only one of which is at one end of the structure.

- *Type V, cantilever overhead sign structure* – A single, rigid, tube-type horizontal arm that is supported at one end by a single tubular support pole.
- *Type VI, bridge overhead sign structure* – A single, rigid, tube-type horizontal structure that is supported at both ends by single tubular support poles.
- *Type VII, bridge-mounted overhead sign structure* – A structural frame that is attached to a grade-separation structure. Caution is to be used in attaching signs to bridges in accordance with the February 8, 1980 [memorandum](#) from J.T. Kratzer, PE, State Bridge Engineer, to Archie C. Burnham, PE, State Traffic and Safety Engineer.
- *Type VIII, butterfly overhead sign structure* – Single rigid tube type horizontal arms extending in opposite directions from a single column support.

Physical gore – The point, as defined in the AASHTO “Green Book,” where the ramp intersects with the mainline facility and the pavement surface changes.

Regulatory signs – Give notice of traffic laws or regulations.

Special Purpose Road – A low-volume, low speed road that serves recreational areas or resource development activities.

Special roadside signs – Guide signs that are manufactured using extruded aluminum panels and that are ground-mounted.

Theoretical gore (“painted gore”) – The point, as defined in the AASHTO “Green Book,” where the ramp separates from the mainline facility.

Warning signs – Give notice of a situation that might not be readily apparent.

1.2 Applicable Standards and Specifications

The following specific documents will govern all work efforts:

[GDOT Standard Specifications – Construction of Transportation Systems](#) – Latest edition and supplements thereto. Documents listed below provide more detail concerning specific traffic engineering design elements, but all work must be in accordance with the GDOT Standard Specifications.

[GDOT Signing and Marking Details](#)

[GDOT Standard Detail Sheets](#)

[GDOT Construction Details](#)

[GDOT Plans Presentation Guide \(PPG\)](#)

[GDOT Electronic Data Guidelines \(EDG\)](#)

[MUTCD](#) – Latest edition adopted by GDOT. This document shall govern those aspects of the application of all signs, signals, and pavement markings.

Standard Highway Signs (Federal Highway Administration [FHWA])

[Americans with Disabilities Act](#)

AASHTO “Green Book” – A Policy on Geometric Design of Highways and Streets as published by AASHTO, latest edition adopted by GDOT. Design standards outlined in this publication shall govern most geometric considerations. This publication provides guidance on the physical design of highways and streets.

AASHTO Standard Specifications for Structural Supports for Highway Signs, Luminaries, and Traffic Signals – This document provides criteria for structural design.

[*FHWA Work Zone Traffic Control Practices Manual*](#)

[*Roadside Design Guide*](#)

[*GDOT Design Guide*](#)

Intentionally Left Blank

Chapter 2. General Information - Contents

- Chapter 2. General Information - Contents2-i
- 2.1 Drafting Standards.....2-1
- 2.2 Electronic File Structure2-1
 - 2.2.1 Cell Libraries2-1
- 2.3 Signing and Marking Plan Sheets2-1
 - 2.3.1 Required Information2-1
 - 2.3.1.1 Pavement markings:2-1
 - 2.3.1.2 Raised pavement markers:2-1
 - 2.3.1.3 Signs:2-1
 - 2.3.2 Sheet Layout2-2
- 2.4 General Notes2-2
- 2.5 Summary of Quantities Sheets2-2
- 2.6 Sign Detail Sheets2-3
- 2.7 Clearance Diagrams2-3

Chapter 2. General Information

The following standards apply to the preparation and presentation of signing and marking plans.

2.1 Drafting Standards

Drafting standards shall follow the requirements of the [EDG](#).

2.2 Electronic File Structure

Electronic file structure shall follow the requirements of the [EDG](#).

2.2.1 Cell Libraries

The Office of Traffic Operations has a cell library that contains standard cells for signs and pavement marking items. The signing and marking design cell file (as well as other GDOT design cell files) is available from the [GDOT ROADS web site](#).

2.3 Signing and Marking Plan Sheets

Prepare plan sheets to show all permanent roadway signs and pavement markings as they appear upon completion of the project. Place emphasis on designing clear directional signage, identifying roadway names, and coordinating sign placement with signal or utility poles, roadway features, structures, sight distances, and driver awareness. Signing and marking plan sheets shall be the same scale as the construction plans and should use the same match lines. Signing and marking plan sheets shall follow the requirements of the [PPG](#).

2.3.1 Required Information

2.3.1.1 Pavement markings:

Depict and label all required pavement markings to indicate color, width, and spacing as appropriate on each sheet. While it is not necessary to label each pavement item, at least one note typically referencing the applicable standard should be placed on each sheet. Refer to the Pavement Marking Selection Chart located on page 12-1.

2.3.1.2 Raised pavement markers:

Add raised pavement marker (RPM) information to striping callout. Depict and label all RPMs to indicate color, type, and spacing as appropriate on each sheet. While it is not necessary to label each pavement item, at least one note typically referencing the applicable standard should be placed on each sheet.

2.3.1.3 Signs:

Show the location of required signs symbolically and give a representation of the sign face. Orient the symbol, sign code, and sign face to correspond to the direction of travel of the motorists for which they are intended. Reference the placement station, sign code, and size of each sign in a uniform manner throughout the plan set.

2.3.2 Sheet Layout

The signing and marking plan sheet layout shall follow the requirements of the [PPG](#).

2.4 General Notes

The general notes for signing and marking shall be included in Section 4 General Notes of the plans. Refer to the [PPG](#) for sheet sequence.

Plans may contain the following general note sheets:

- Standard Signs General Notes (Appendix E, E-2)
- Special Roadway Signs General Notes (Appendix E, E-3)
- Overhead Highway Signs General Notes (Appendix E, E-3)

2.5 Summary of Quantities Sheets

Quantities for pavement markings and signs are presented on separate sheets. Typically, the removal of pavement markings and signs is paid for as part of traffic control lump sum; therefore, it should not be in the summary of quantities unless it is a special circumstance. This is covered in Section 150 of the [GDOT Standard Specifications for Construction of Transportation Systems](#).

The Summary of Quantities for Pavement Markings sheet lists the type and quantity for traffic stripes, raised pavement markers, arrows, words, and symbols.

The Summary of Quantities for Standard Signs sheet presents sign and sign post quantities in a tabular format. Each sign is listed separately by station and sign code. No two separate sign installations shall have the same station number. All signs should be offset by 1 foot, if necessary. There are separate columns for Type 1 and Type 2 sign material and Type 9 and Type 11 reflective sheeting material. Sign posts are separated into Type 7, 8, and 9 posts. If there is more than one sign on a post, then the post is listed in the same row as the first sign on the post.

The Summary of Quantities for Signing and Marking shall be included within the plan assembly's summary of quantities section. Refer to the [PPG](#) for sheet sequence.

Signing and marking plans may contain the following summary of quantity sheets:

- [Summary of Quantities – Pavement Markings](#)
- [Summary of Quantities – Standard Signs](#)
- [Summary of Quantities – Special Roadside Signs](#)
- [Summary of Quantities – Remove and Remount Special Roadside Signs](#)
- [Summary of Quantities – Overhead Highway Signs](#)
- [Summary of Quantities – Remove Overhead Highway Signs and Structures](#)
- [Summary of Quantities – Remove and Reset of Logo Signs](#)
- [Summary of Quantities - Delineator and Milepost](#)

2.6 Sign Detail Sheets

Sign detail sheets shall be developed for special signs or signs with unique or non-standard legends. Sign detail sheets shall be located after the signing and marking plan sheets. Sign templates are provided in [Appendix A](#) of this document.

2.7 Clearance Diagrams

Clearance diagrams shall be developed for overhead highway signs. Clearance diagrams shall be located after signing and marking plan sheets.

Additional requirements for [clearance diagrams](#) are included in subsequent sections of this document.

Intentionally Left Blank

Chapter 3. Sign Design Standards - Contents

Chapter 3. Sign Design Standards - Contents	3-i
3.1 General Sign Guidelines.....	3-1
3.2 Regulatory Signs	3-1
3.2.1 Stop Signs (R1-1).....	3-1
3.2.2 Yield Signs (R1-2)	3-1
3.2.3 Speed Limit Signs (R2-1)	3-2
3.2.4 Right (Left) Lane Must Turn Right Signs (R3-7).....	3-2
3.2.5 Keep Right Signs (R4-7)	3-2
3.2.6 Do Not Enter Signs (R5-1)	3-2
3.2.7 Wrong Way Signs (R5-1a)	3-2
3.2.8 Divided Highway Crossing Signs (R6-3)	3-2
3.2.9 State Line Signing	3-3
3.2.10 Selective Exclusion Signs (R5-10a)	3-3
3.3 Warning Signs	3-3
3.3.1 W3-1 and W3-3	3-3
3.3.2 W3-5.....	3-3
3.3.3 Road Name Signs Used in Conjunction with Warning Signs (W16-8)	3-3
3.3.4 Bicycle Warning Signs (W11-1).....	3-4
3.3.5 Share the Road Signs (W16-1)	3-5
3.3.6 Bikes May Use Full Lane Signs (R4-11)	3-5
3.3.7 Required Signs at “T” Intersections and Road Ends	3-5
3.4 Guide Signs	3-6
3.4.1 Route Markers.....	3-6
3.4.1.1 Placement Guidelines	3-6
3.4.1.2 Mile Post Signing	3-6
3.4.2 Political Boundary Signs.....	3-6
3.4.3 Directional Signs for Recreation and Cultural Interest Areas	3-6
3.4.3.1 Memorial or Dedication Signs	3-6
3.4.4 Tourist-Info Visitor Center	3-7
3.4.5 Public Interest Open House (PIOH) Signs	3-7
3.4.6 Lettering Guidelines	3-7
3.5 School Zone and Pedestrian Crossing Signs	3-7
3.6 Overhead Signs.....	3-8
3.7 Sign Posts	3-9
3.7.1 Description	3-9

3.7.2 Wind Loads3-9

Chapter 3. Sign Design Standards

3.1 General Sign Guidelines

The following are design guidelines regarding the development of signing plans:

1. Sign sizes are determined by the roadway classification. The standard sign size (as defined in tables within in various Parts of the MUTCD and in the “Standard Highway Signs and Marking” book Section 1A.11 and 12) shall be used on two-lane and four-lane roads regardless of speed limit; on divided roads with four lanes or more and speed limits less than 50 miles per hour (mph); and on roads with five lanes or more and speed limits of 45 mph or less. With the exception of route confirmation signing, the expressway sign size is to be used on divided four-lane or more roads with speed limits of 55 mph or greater and on five-lane or more roads with speed limits greater than 50 mph. The freeway sign size is to only be used on interstates and other freeways.
2. Use standard size signage on off ramps to ramps to non-freeway facilities
3. Single-plate signs greater than 9 square feet in area and/or greater than 48 inches in width shall be erected on two posts.
4. Type 1 material is used on signs with areas less than or equal to 9 square feet, while Type 2 material is used on signs greater than 9 square feet in area or greater than 48 inches in width. Type 1 and Type 2 material refers to the sign blank itself. The difference between Type 1 and Type 2 material is the thickness of the sign blank (.08 inch for Type 1 and .10 inch for Type 2).
5. The second specification in the signing pay items refers to reflective sheeting. Type 9 and Type 11 is a wide-angle prismatic lens and is also referred to as very high intensity. The use of each type of reflective sheeting is defined in the following subsection.
6. Signs shall not be placed back-to-back on one post unless they are identical in size and shape.

3.2 Regulatory Signs

All red series signs (R1-1, R1-2, R1-3p, R5-1, and R5-1a) shall have Type 11 (very high intensity) reflective sheeting backgrounds. All other regulatory signs shall have Type 9 (very high intensity) reflective sheeting backgrounds unless specified otherwise.

3.2.1 Stop Signs (R1-1)

Stop signs on state routes or on roads approaching state routes should be a minimum of 36 inches in width. Stop signs of 48 inches in width should only be used based on engineering judgment on the basis of an engineering study or in accordance with traffic engineering practices.

3.2.2 Yield Signs (R1-2)

Yield signs on state routes and/or on roads approaching state routes should be a minimum of 36 inches in width on conventional roads and 48 inches in width on expressways.

3.2.3 Speed Limit Signs (R2-1)

Speed limits on non-interstate roads should be confirmed after every junction with a numbered (state or U.S.) route. In rural areas in the absence of junctions with numbered routes, speed limits are to be confirmed at a maximum 5 mile interval, with a preferred 2 mile interval and at political boundaries. In more developed or higher vehicular volume areas, this interval should be reduced to a 2 mile interval. Speed limit signs are also placed at speed limit changes.

3.2.4 Right (Left) Lane Must Turn Right Signs (R3-7)

Right Lane Must Turn Right signs should be used when the right turn lane drops (trap lane). Left Lane Must Turn Left signs should be used when the left lane drops only. Refer to Section 2B.19.05 of the 2009 MUTCD edition.

3.2.5 Keep Right Signs (R4-7)

R4-7 signs (Keep Right) should be installed only at the beginning of a physical median (raised or depressed) and on raised medians only when the median width (face-of-curb to face-of-curb distance) is 4 feet or greater. Install ten (10) feet behind nose. Refer to Figure B-1 in [Appendix B](#).

3.2.6 Do Not Enter Signs (R5-1)

R5-1 signs (Do Not Enter) should be placed on the outside shoulder and should not be placed more than 50 feet from the median nose station measured along the roadway. Other locations are approximate.

Oversized (48" x 48") signs should be used at the end of off-ramps to deter wrong way drivers from accessing the roadway in the wrong direction. The mounting height should be between three and four feet (MUTCD, Section 2B.41 Par 6).

3.2.7 Wrong Way Signs (R5-1a)

R5-1a signs (wrong way) should be placed on median divided roadways 200 feet from R5-1 (do not enter) signs.

3.2.8 Divided Highway Crossing Signs (R6-3)

R6-3 signs (divided highway crossing) should be used under R1-1 signs only on divided roadways. R6-1 signs (one way) should be used on all divided roadways with medians that are greater than 30 feet wide. Divided roadways with medians less than 30 feet wide should not include R6-1 signs. See Figures 2B-15 and 2B-16 of the 2009 MUTCD.

3.2.9 State Line Signing

Specific signs and sign sequences are required on all roadways entering the state. Refer to Figure 3-1 for all signs and sign installation order that shall be installed on expressways and conventional roadways. Contact GDOT Office of Traffic Operations for freeway (limited access) roadway signage.









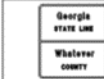

3.2.10 Selective Exclusion Signs (R5-10a)

R5-10a signs shall be added to the right shoulder of all interstate and major freeway on-ramps.

3.3 Warning Signs

All warning signs on State Routes shall have Type 11 (very high intensity) reflective sheeting backgrounds and shall be a minimum of 36 inches. The setback distance for intersection warning signs shall be as recommended in the 2009 MUTCD, Table 2C-4. This distance shall be measured from either the radius point of the crossroad or the stopping point (stop bar) when there is no deceleration lane. When turn lanes are present, intersection advance warning signs shall be placed a minimum of 150' in advance of the beginning of the taper(s).

FIGURE 3-1
STATE LINE SIGNING SEQUENCE
(NON-LIMITED ACCESS)

	SPECIAL DESIGN	2 LANE	... ¹ x 36 ¹
		4 LANE, 5 LANE, 4 LANE DIVIDED	... ¹ x 36 ¹
	SPECIAL DESIGN	2 LANE	72 ¹ x 48 ¹
		4 LANE, 5 LANE, 4 LANE DIVIDED	72 ¹ x 48 ¹
	M3-1, 2, 3, OR 4	SEE MUTCD FOR SIGN DIMENSIONS	
	MI-4 OR MI-5	SEE MUTCD FOR SIGN DIMENSIONS	
	R2-1	SEE MUTCD FOR SIGN DIMENSIONS	
	R550-1	2 LANE, 5 LANE	30 ¹ x 36 ¹
		4 LANE, 4 LANE DIVIDED	30 ¹ x 36 ¹
	R553-1	2 LANE, 5 LANE	24 ¹ x 30 ¹
		4 LANE, 4 LANE DIVIDED	36 ¹ x 48 ¹
	R560-1	2 LANE, 5 LANE	30 ¹ x 36 ¹
		4 LANE, 4 LANE DIVIDED	30 ¹ x 36 ¹
	R554-1	2 LANE, 5 LANE	24 ¹ x 30 ¹
		4 LANE, 4 LANE DIVIDED	36 ¹ x 48 ¹
	R560-2	2 LANE, 5 LANE	30 ¹ x 36 ¹
		4 LANE, 4 LANE DIVIDED	30 ¹ x 36 ¹

NOTES:
 1. INSTALL SIGNS ON ALL ROUTES ENTERING THE STATE. IF THERE IS INSUFFICIENT SPACE FOR ALL SIGNS, THE ORDER OF PREFERENCE IS FROM TOP TO BOTTOM OF THIS CHART.
 2. R550-1 SIGNS ARE INSTALLED ONLY IN COUNTIES THAT HAVE PERMITS TO OPERATE DETECTION DEVICES.

Figure 3-1

3.3.1 W3-1 and W3-3

W3-1 and W3-3 signs may be measured from the intersection stopping point (stop bar).

3.3.2 W3-5

W3-5 signs may be used in conjunction with speed limit reductions and shall be placed in accordance with section 2B.13 of the 2009 MUTCD.

Guidance for the curve ahead can be found in the 2009 MUTCD, Table 2C-5 (Horizontal Alignment Sign Selection).

3.3.3 Road Name Signs Used in Conjunction with Warning Signs (W16-8)

These signs are supplemental to warning signs and shall have yellow reflectorized backgrounds with black legends, borders, and symbols.

W16-8 signs (road name signs) shall be used in rural areas when the side road has a local name only. County road numbers shall not be used on W16-8 road name signs. W16-8 signs shall be

installed below the W2-X (advance intersection warning) sign or the W3-3 (signal ahead) sign (when used). W16-8A shall be used for locations with two different named roads with arrows pointing to side.

Four-inch lettering should be used on all conventional W16-8 signs and six-inch lettering should be used on expressway signage with the first letter upper case and the remaining letters lower case. The maximum width of the sign is recommended to be within 10% of the advanced warning sign width. Refer to Table 2C-2 (page 107) Figure 2C-12 (page 132) MUTCD.

Series D font should be used for the proposed lettering on signs. If using Series D font causes the sign to exceed the maximum width stated in the previous paragraph, Series C can then be used, followed by Series B font. Refer to Table 3.1 for an example.

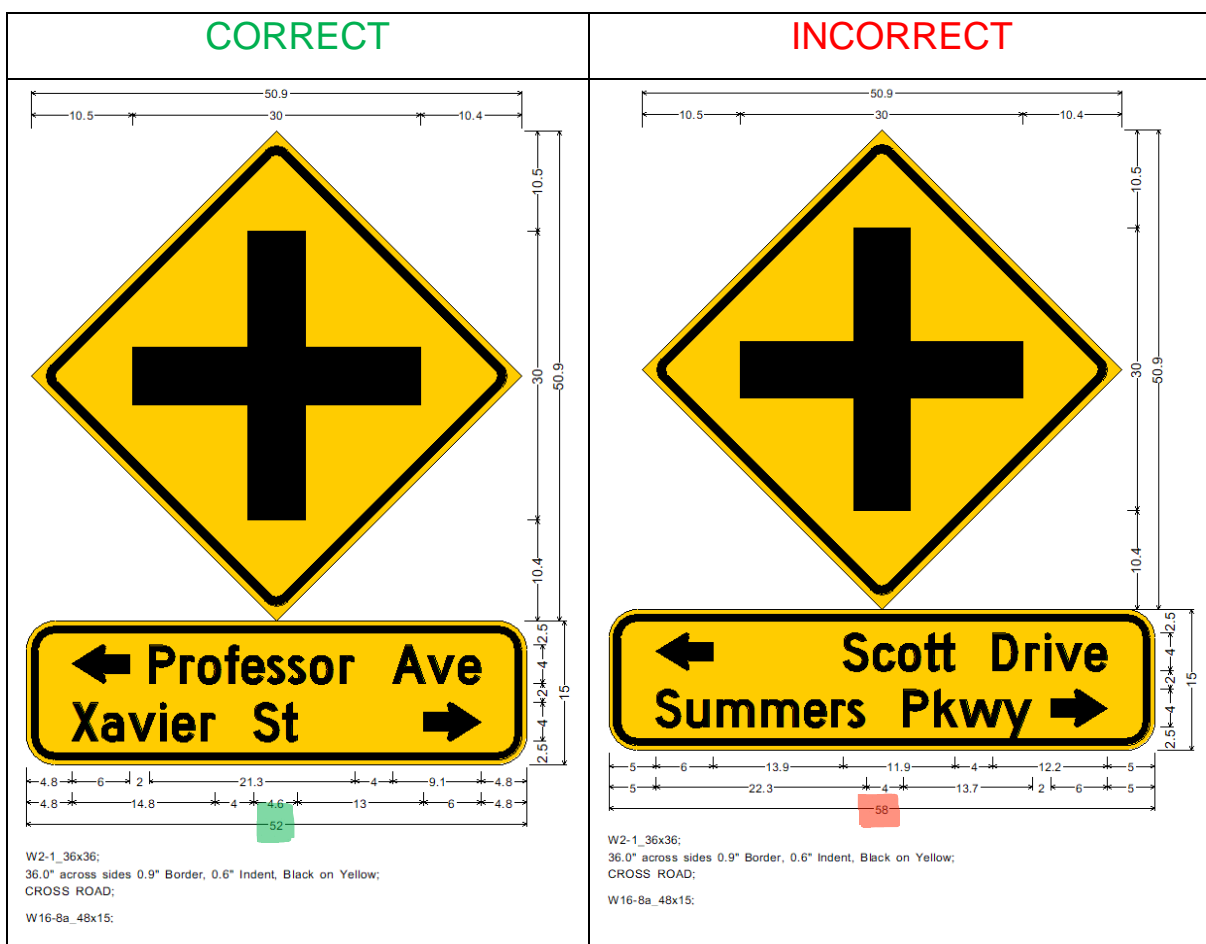

Table 3-1

3.3.4 Bicycle Warning Signs (W11-1)

Bicycle warning signs should be placed on roadways intersecting those that have bicycle facilities, i.e. bike lanes or shoulders as depicted in [Appendix C](#).

3.3.5 Share the Road Signs (W16-1)

The share the road sign is used in conjunction with the W11-1P warning sign. The “bikes may use full lane” (R4-11) sign, described in Section 3.3.6, is preferred, rather than the “share the road” (W16-1P) sign. The “bikes may use full lane” sign more clearly communicates the proper interaction of motorists and bicyclists on the roadway. The “share the road” sign may be implemented in very rural areas where motorists typically travel at speeds greater than 40mph or areas with inadequate sight distance to serve as a warning of bicyclists on the roadway. The “share the road” sign should not be used on roads with dedicated bicycling facilities such as striped bicycle lanes, protected bicycle lanes, or paved bikeable shoulders (shoulders with at least 4-ft of smooth paved surface not interrupted by rumble strips). Roadways where paved shoulders or bicycle lanes are present will not be considered unless a special safety or road courtesy problem exists.

3.3.6 Bikes May Use Full Lane Signs (R4-11)

The “bikes may use full lane” is appropriate for alerting motorists to the lawful position of bicyclists in their line of travel. It is lawful for bicyclists to travel on all non-limited access roadways in Georgia; the use of the “bikes may use full lane” sign brings added attention in locations that meet any of the criteria listed below. An optional placard reading “change lanes to pass” is appropriate on roadways where a motorist must change lanes in order to give the lawful 3-ft of passing clearance and is on a multilane roadway. Similar to the “share the road” sign, the “bikes may use full” sign should not be used on roads with dedicated bicycling facilities such as striped bicycle lanes, protected bicycle lanes, or paved bikeable shoulders (shoulders with at least 4-ft of smooth paved surface not interrupted by rumble strips). Roadways where paved shoulders or bicycle lanes are present will not be considered unless a special safety or road courtesy problem exists.

Signs should be considered for installation at locations that meet at least one of the following criteria:

- Where there is significant bicycle traffic (where motorists are likely to pass one or more bicyclists at least every three miles during peak traffic hours).
- After a bike lane ends and bicyclists and motorists enter a shared lane situation.
- On stretches of road that are used to connect two sections of a shared use path.
- Roadway sections with a significant history of bicycle crashes.
- Where there is a documented conflict or courtesy problem between motor vehicles.
- Where there are gaps in paved shoulders or where shoulder width is reduced.
- Where curb lane widths are narrower than 12' for multi-lane roadways, or narrower than 14' for 2-lane roadways.

3.3.7 Required Signs at “T” Intersections and Road Ends

At three-legged “T” intersections, the W1-7 double-head arrow sign and OM4-3 signs should be installed per 2009 MUTCD sections 2C.47 and 2C.66, respectively. The OM4 signs should be mounted on separate posts as shown in the Appendix F, Figure 3-10, although in constrained areas they may be mounted on the posts for the W1-7 (if double-posted). (Note: OM3 signs shall not be used at “T” intersections or road ends.)

3.4 Guide Signs

3.4.1 Route Markers

Route markers are either 24 inches in width (one- or two-digit numbers) or 30 inches in width (three-digit numbers) on all roads, except on limited-access roads, where they are either 36 inches in width (one- or two-digit numbers) or 45 inches in width (three-digit numbers). Cardinal direction signs are 24 inches in width on all roads, except on limited-access roads, where they are 30 inches in width.

When more than one type of route marker is used within an assembly, the order of preference is interstate, U.S., state (left to right, top to bottom). Within the same classification of route marker, the order of preference is from lowest number to highest number.

3.4.1.1 Placement Guidelines

Routes shall be confirmed after every junction with a numbered (state or U.S.) route. In rural areas in the absence of junctions with numbered routes, the routes are to be confirmed at a maximum 5-mile interval and a preferred 2-mile interval. In more developed or higher vehicular volume areas, this interval should be reduced to a 2 mile interval.

[Figure 3-2](#), [Figure 3-3](#), and [Figure 3-4](#) provide typical route signing through different cases of intersecting routes. These figures show four-lane divided roads, but they also apply to two-lane roads. “Overhead span wire” signs should be used on approaches of all multilane state route approaches to other state routes. The use of overhead signs may eliminate the need for some shoulder mounted signs. See section 3.6.

3.4.1.2 Mile Post Signing

Mile Post signs shall be confirmed at 1-mile intervals. In areas where roads are barrier separated, Mile Post signs shall be confirmed at 0.2 miles intervals.

3.4.2 Political Boundary Signs

Political boundary signs, I-2, shall consist of a single City or County name on each sign or one sign blank with a separation line when the City Limits and the County Line are at the same location.

3.4.3 Directional Signs for Recreation and Cultural Interest Areas

Directional signs that are recreationally or culturally oriented shall have Type 9 (very high intensity) brown reflectorized backgrounds with white reflectorized legends, borders, and symbols.

3.4.3.1 Memorial or Dedication Signs

Memorial or dedication sign shall follow the same design guidelines as the I-3 Information signs. Signs shall have a Type 9 (very high intensity) brown reflectorized background with white reflectorized legend and borders.

Memorial or dedication signs should be limited to one per intersection or interchange in total for each direction.

3.4.4 Tourist-Info Visitor Center

Directional signs used for tourist-oriented purposes shall have blue Type 9 (very high intensity) reflectorized backgrounds with white reflectorized legends, borders, and symbols. Per 2009 MUTCD, Section 2K on page 320.

3.4.5 Public Interest Open House (PIOH) Signs

Information on PIOH signs should be limited to the following:

- GDOT Public Meeting
- Project Location/ PI #
- Project Type
- Meeting Time and Location

Signs shall have Type 9 (very high intensity) white reflectorized background with black legend and borders. Text should be 3" in height typically and increased to 5" on roadways with a speed limit greater than 45 mph. Signs should be limited to two (2) sign posts. Signs shall be placed on their own sign posts, independent of any additional signs, proposed or existing.

3.4.6 Lettering Guidelines

For non-interstate signs, there shall not be more than a one-series difference between legends within a sign (i.e., use Series D and C, not Series D and B).

Spacing shall not be reduced by more than 30%.

The most recent GDOT-approved software program shall be used for all sign designs.

3.5 School Zone and Pedestrian Crossing Signs

All school zone signs (S1-1, S2-1, S3-1, S4-3, S4-5 and the top portion of S5-1) and pedestrian crossing signs (W11-2) shall have Type 11 (very high intensity) fluorescent yellow-green (FYG) reflective sheeting backgrounds. All regulatory signs placed as part of the school zone signing shall have Type 9 (very high intensity) reflective sheeting backgrounds of the appropriate color.

3.6 Overhead Signs

Overhead signs shall be used whenever there are multiple turn lanes in any one direction (dual left-turn lanes or dual right-turn lanes). On state routes, U.S. routes, or interstate ramps, overhead span wire signs should be used on the approaches of multilane state route approaches to other state routes.

Overhead signs may be used in other situations based upon engineering judgment. If overhead signs are used, some shoulder-mounted post signs can be omitted. See Overhead Signing Detail ([Figure 3-9](#)) for proper placement on the span wire.

Overhead Street Name signs shall be composed of initial upper & lower case letters, 11 inches in height, on 18 inch sign blank without a border. Signs shall have 2.5 inch spacing on top and 4.5 inch spacing on bottom. The total length of sign should not exceed 120 inches.

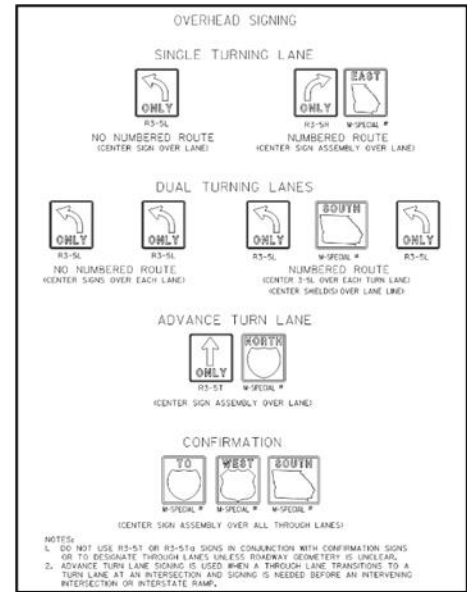

Figure 3-2

Typical sign installations on surface streets will be post-mounted in accordance with the MUTCD. The following is a list of situations that may warrant the installation of overhead signing instead of a post-mounted sign, but each individual occurrence must be properly studied and concurrence received from the General Office of Traffic Operations before a final determination is made:

- Traffic volumes at or near capacity
- Complex intersection and/or signalization design
- Three or more traffic lanes in each direction
- Restricted sight distance
- Closely spaced intersections
- Interstate exit ramps
- High percentage of truck traffic
- Very high travel speeds
- Insufficient space for ground signs
- Dropping a through lane as a turn-only lane

All overhead span wire signs shall have Type 9 (very high intensity) reflective sheeting. Strain poles for overhead span wire signs shall be shown on construction and utility plan sheets with station & offset in accordance with the [EDG](#).

It is recommended that the levels for drainage and utilities be turned on temporarily while placing strain poles to minimize conflicts.

3.7 Sign Posts

3.7.1 Description

Type 7, 8, and 9 sign posts are square tube posts. Type 8 posts are larger than Type 9 posts. Type 9 posts are larger than Type 7 posts. Only Type 8 posts may be installed on a breakaway sign support. For reference, see Construction Detail T-3A and T-3B.

3.7.2 Wind Loads

The primary factor in selecting the appropriate type of post is the amount of resistance required to withstand the applied wind load. Use Construction Detail T-3A and T-3B to select the proper square tube post.

Intentionally Left Blank

Chapter 4. Location and Sequence of Signs (Interstate/Freeway) - Contents

Chapter 4. Location and Sequence of Signs (Interstate/Freeway) - Contents.....	4-i
4.1 Exit Signing.....	4-1
4.2 Post-Interchange Sequence Signing	4-2
4.3 Mile Post Signs.....	4-3
4.4 Political Boundary Signs.....	4-3
4.4.1 Specialty Signs for Champion Signs	4-3
4.5 Waterway Signs.....	4-3
4.6 Hospital Signs.....	4-3
4.7 Bridge Caution Signs.....	4-4
4.8 No Trucks Over 6 Wheels Allowed in Left X Lanes Signs	4-4
4.9 Truck Use I-285	4-4
4.10 Emergency Parking Only Signs	4-4
4.11 Up to \$1,200 Fine for Throwing Trash on Highway Signs	4-4
4.12 Slower Traffic Keep Right Signs.....	4-4
4.13 Keep Off Median Signs.....	4-4
4.14 Reduced Speed Ahead Signs	4-4
4.15 Overhead Regulatory Signs	4-4

Chapter 4. Location and Sequence of Signs (Interstate/Freeway)

To provide for proper spacing between signs and to provide consistent information to the motoring public, a standard sequence and spacing are desirable when exiting and entering an interstate or other limited-access facility. It is desirable to locate signs at a minimum 800 feet apart; however, because of physical constraints, this may not be possible. As a minimum, the designer should maintain spacing at 500 feet between signs.

4.1 Exit Signing

The timely display of information provides the road user exiting a limited-access facility with critical information to make a decision without being confused. The MUTCD classifies interchanges as follows:

Major interchanges – Subdivided into two categories: (a) interchanges with other expressways or freeways; or (b) interchanges, other than those named in (a), with high-volume multilane highways, principal urban arterials, and major rural routes where the volume of interchanging traffic is heavy or includes many road users unfamiliar with the area.

Intermediate interchanges – Interchanges with urban or rural routes not in the category of major or minor interchanges as defined herein.

Minor interchanges – Interchanges with local, very light traffic, such as interchanges with land service access roads. Where the sum of exit volumes is estimated to be lower than 100 vehicles per day in the design year, the interchange is classified as minor.

For major interchanges, two advance guide signs shall be used, but three signs are preferred. Placement should be at 2 miles, 1 mile, and 0.5 mile in advance of the theoretical gore of the exit when three signs are used. When only two advance guide signs are used, they shall be placed 1 mile and 0.5 mile in advance of the theoretical gore of the exit.

For intermediate and minor interchanges, two advance guide signs should be used. Placement should be at 1 mile and 0.5 mile from the theoretical gore of the exit.

All interstates with three or more lanes in each direction require overhead guide signs. All interstates with four or more lanes in each direction require signs to be placed over travel lanes.

All interchanges require an overhead exit guide sign placed at the theoretical gore of the exit ramp. [Figure 4-1](#) indicates the locations of the required exit signs.

Rest areas require only one advanced exit sign placed 1 mile in advance of the theoretical gore of the ramp. An exit gore sign is required at the physical gore of the exit ramp.

All signing in a given direction should display destinations in order with the closest destination listed first. If the destinations include a road, the road should be listed first on the signs.

For interchanges where it is desirable to indicate more than two destinations, a supplemental sign may be used. Supplemental guide signs should be located between the 0.5-mile and 1-mile exit signs.

The use of other signs within the exit sign sequence is to be avoided unless the signs are political boundary signs or required regulatory signs, warning signs, or logo signs. When possible, logo signs should be placed before the 1-mile sign (see [Section 11](#)).

The default background color for all guide signs is green. For guide signs that are clearly associated with cultural and recreational destinations, the background shall be brown. Interstate shields and guide signs for evacuation routes shall have a blue background. In addition, information signs concerned with road user services shall have a blue background. These signs include ride share, 511, hospital, rest area, dial 911, and tourist information signing. These signs shall have Type 9 (high intensity) Reflective Sheeting. Refer to Color Code per 2009 MUTCD, Section 1A.12.

Color Code

- A. Black—regulation
- B. Blue—road user services guidance, tourist information, and evacuation route
- C. Brown—recreational and cultural interest area guidance
- D. Coral—unassigned
- E. Fluorescent Pink—incident management
- F. Fluorescent Yellow-Green—pedestrian warning, bicycle warning, playground warning, school bus and school warning
- G. Green—indicated movements permitted, direction guidance
- H. Light Blue—unassigned
- I. Orange—temporary traffic control
- J. Purple—lanes restricted to use only by vehicles with registered electronic toll collection (ETC) accounts
- K. Red—stop or prohibition
- L. White—regulation
- M. Yellow—warning

4.2 Post-Interchange Sequence Signing

If an interchange is for new traffic that is entering the facility, the sign sequence must identify the route and speed limit. Interchanges associated with traffic that is continuing on the facility (e.g., rest areas, weigh stations) do not require a post-interchange sign sequence. The standard sequence of signs to be provided is described below and is shown in [Figure 4-2](#).

Merge Sign – If the entrance ramp is a non-continuing lane, the merge sign shall be a W4-1X (48), where the X shall be either R (for right) or L (for left) depending on the side of the mainline road on which the ramp is located. The W4-1X (48) sign shall be located 500 feet in advance of the physical gore of the entrance ramp. The W4-5 sign shall be used on entrance ramps when the mainline W4-1 is not visible from the ramp.

Added Lane Sign – If the entrance ramp is a continuing lane, the added lane sign shall be a W4-3X (48), where the X shall be either R (for right) or L (for left) depending on the side of the mainline road on which the ramp is located. The W4-3X(48) sign shall be located as close as possible to the physical gore of the entrance ramp and where the sign may be viewed by both mainline and

entrance ramp traffic. The W4-6 sign shall be used on entrance ramps when the mainline W4-3 sign is not visible from the ramp.

Route Confirmation Sign – The route shield(s) and direction(s) should be indicated 500 feet beyond the end of the entrance ramp.

Speed Limit Sign – The speed limit sign should be placed 1,000 feet beyond the route confirmation sign. Refer to [GA CODE § 40-6-181](#).

Minimum Speed Sign – The minimum speed sign should be placed 1,000 feet beyond the speed limit sign (when used).

Distance Sign – As an option, a distance sign may be used that gives the distance to the next exit and a control city. This sign should be located 1,000 feet beyond the speed limit sign in place of the minimum speed sign. The mileage shall be the distance to the center of the destination. Any destinations listed on the sign other than the control city shall be associated with the next exit.

In locations with closely spaced interchanges, the post-interchange sequence may have to be altered or eliminated because of exit signing for the next interchange.

4.3 Mile Post Signs

D10-4 signs should be placed every 1 mile. D10-5 signs should be placed every 0.2 mile in areas where barrier medians exist.

4.4 Political Boundary Signs

Political boundary signs on the interstate are required at the boundary of political entities (county and city). These signs must be placed as close to the actual boundary as possible and shall have a green background. If the political entity has a speed detection permit, then an I550-1 sign (speed checked by detection devices) is required and should be located 500 feet beyond the political boundary sign (see [Figure 4-3](#)).

4.4.1 Specialty Signs for Champion Signs

While the use of these signs is not encouraged, if used, signs must be approved by the District Traffic Engineer and should be clustered together at or near the political boundary outside the shoulder points vs. spread out along the roadside.

4.5 Waterway Signs

Signs indicating waterways shall be posted only if the waterway is located on the state map. These signs shall have a green background and shall be placed immediately prior to the waterway crossing. Refer to 2009 MUTCD, Figure 2H-1.

4.6 Hospital Signs

Hospital signs are supplemental guide signs and shall have a blue background. Placement of these signs shall be in accordance with GDOT's Policy and Procedures (P&P) 6775-1.

4.7 Bridge Caution Signs

W8-13 signs (bridge ices before road) shall be located 500 feet in advance of any bridge structure on freeways and interstates. W8-13 signs shall be included in advance of bridge structures on other roadways and should be placed per MUTCD Table 2C-4. Refer to MUTCD section 2C.32 for more information.

4.8 No Trucks Over 6 Wheels Allowed in Left X Lanes Signs

R554-X signs (no trucks over 6 wheels allowed in left X lanes) are standard regulatory signs that are attached to overhead road bridge structures. The value of X is determined by subtracting 2 from the number of lanes (including a high-occupancy vehicle lane if present).

4.9 Truck Use I-285

The R554-11 sign (all thru trucks over 6 wheels must use I-285) is a standard regulatory sign that is attached to overhead road bridge structures (see [Figure 4-4](#)).

4.10 Emergency Parking Only Signs

R8-4 signs (emergency parking only) are standard regulatory signs that should be posted at 8- to 10-mile intervals.

4.11 Up to \$1,200 Fine for Throwing Trash on Highway Signs

R553-1 signs (up to \$1,200 fine for throwing trash on highway) are standard regulatory signs that should be posted at 8- to 10-mile intervals and at the state boundary (see [Figure 4-6](#)).

4.12 Slower Traffic Keep Right Signs

R4-3 signs (slower traffic keep right) are standard regulatory signs that should be posted at 6- to 8-mile intervals. This sign is to be posted on the left side of the road (in the median).

4.13 Keep Off Median Signs

R11-1 signs (keep off median) are standard regulatory signs that should be posted at 6- to 8-mile intervals in areas where there is a grassed median. This sign is to be posted on the left side of the road (in the median).

4.14 Reduced Speed Ahead Signs

W3-5 signs (reduced speed ahead) shall be posted in advance of speed limit reductions, per MUTCD.

4.15 Overhead Regulatory Signs

R570-1 (move over...) & 570-2 (move accidents...) signs should be posted at approximately 20-mile intervals and at the state boundary. Refer to [Figure 4-8](#) in Appendix F.

Chapter 5. Specific Sign Sequencing for Particular Applications - Contents

Chapter 5. Specific Sign Sequencing for Particular Applications - Contents	5-i
5.1 Lane Reduction for Interstates	5-1
5.2 Lane Reduction for Conventional Roads.....	5-2
5.3 Lane Reduction for Conventional Roads.....	5-2
5.4 Lane Drop – Continuous to Exit Lane.....	5-4
5.5 Lane Drop – Auxiliary Lane	5-5
5.6 Lane Drop – Drop Option	5-6
5.7 Lane Drop – Drop Option Auxiliary Lane.....	5-6

Chapter 5. Specific Sign Sequencing for Particular Applications

The sequence and spacing of signs for specific applications are defined and should be adhered to using sound engineering judgment. These particular applications are lane reduction, lane drop (continuous lane), and lane drop (auxiliary lane).

5.1 Lane Reduction for Interstates

The lane reduction application is used for ending a lane between interchanges. See [Figure 5-1R](#) for a right-lane drop and [Figure 5-1L](#) for a left-lane drop. These figures indicate the four warning signs, the sign spacing, and the pavement marking spacing required. The signs are:

- W20-5AX (0.5 mile) – Right/left lane ends in 0.5 mile
- W20-5AX (1500 FT) – Right/left lane ends in 1,500 feet
- W9-1X – Right/left lane ends
- W4-2X – Graphical right/left lane ends

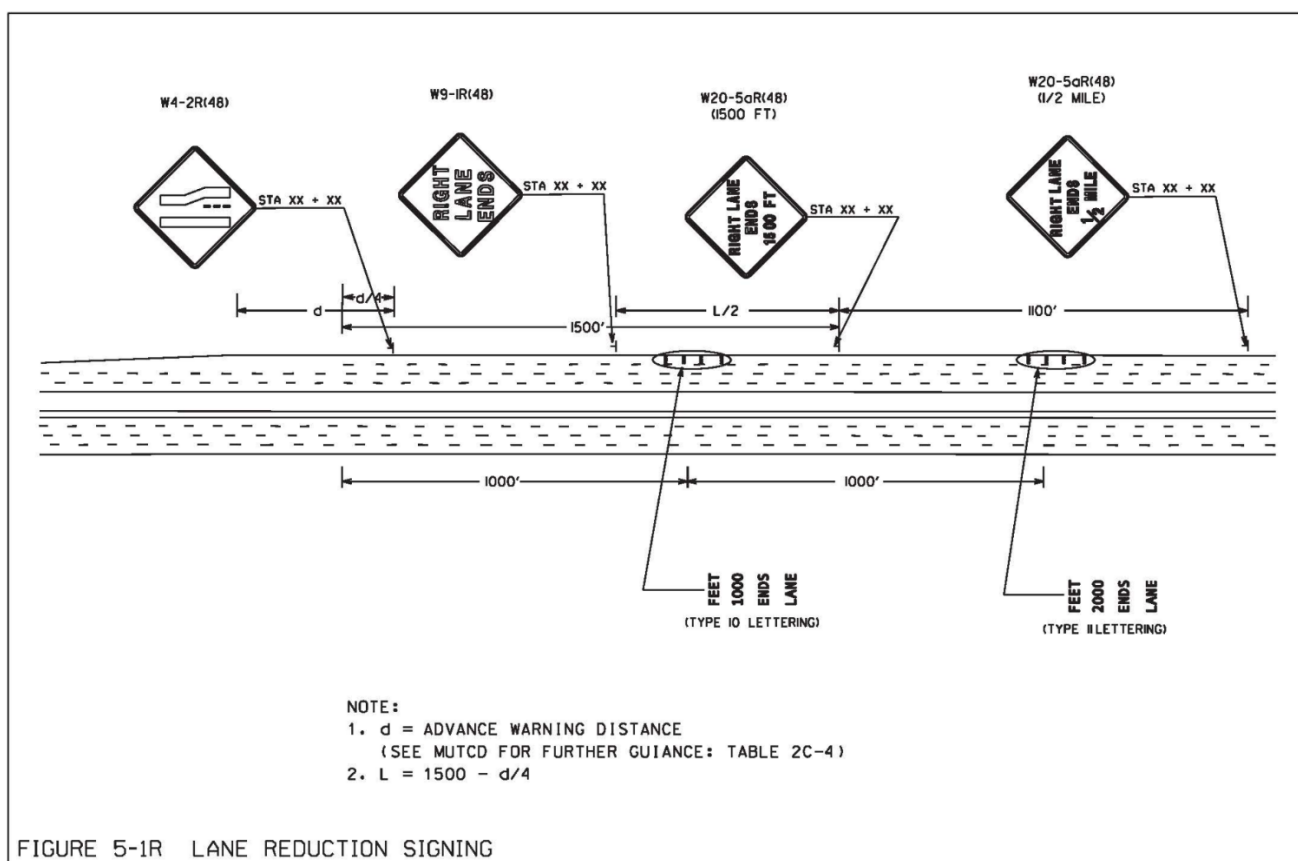

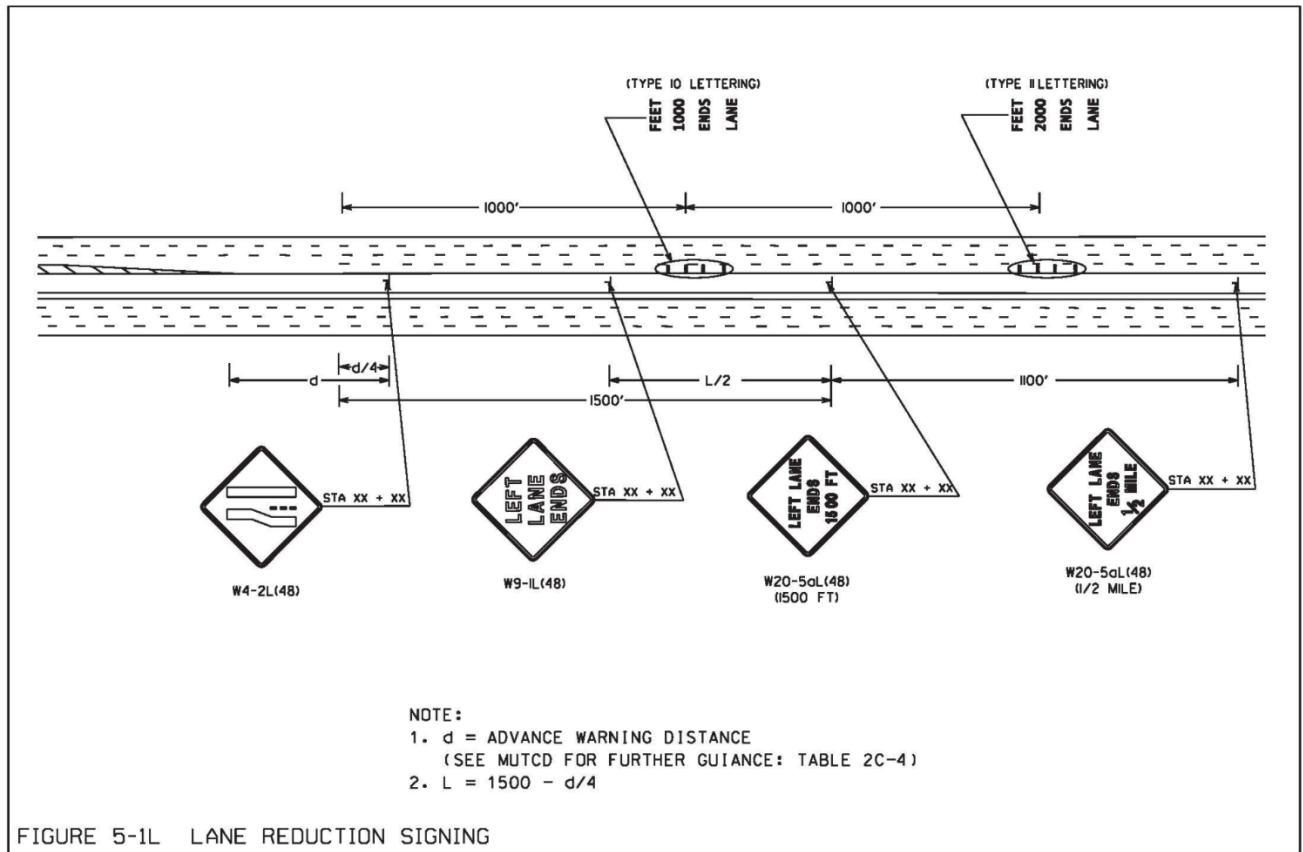

5.2 Lane Reduction for Conventional Roads

If there is insufficient room for all three lane width transition signs, omit the W9-2 sign. If there is insufficient room for the remaining two lane width transition signs, use the W4-2 sign only. The lane reduction signing requirements are shown on [Figure B-1](#).

5.3 Lane Reduction for Conventional Roads

The lane drop application is used where the lane has been continuous prior to the intersection. Figure 5-3C indicates the specific signs and pavement markings required.

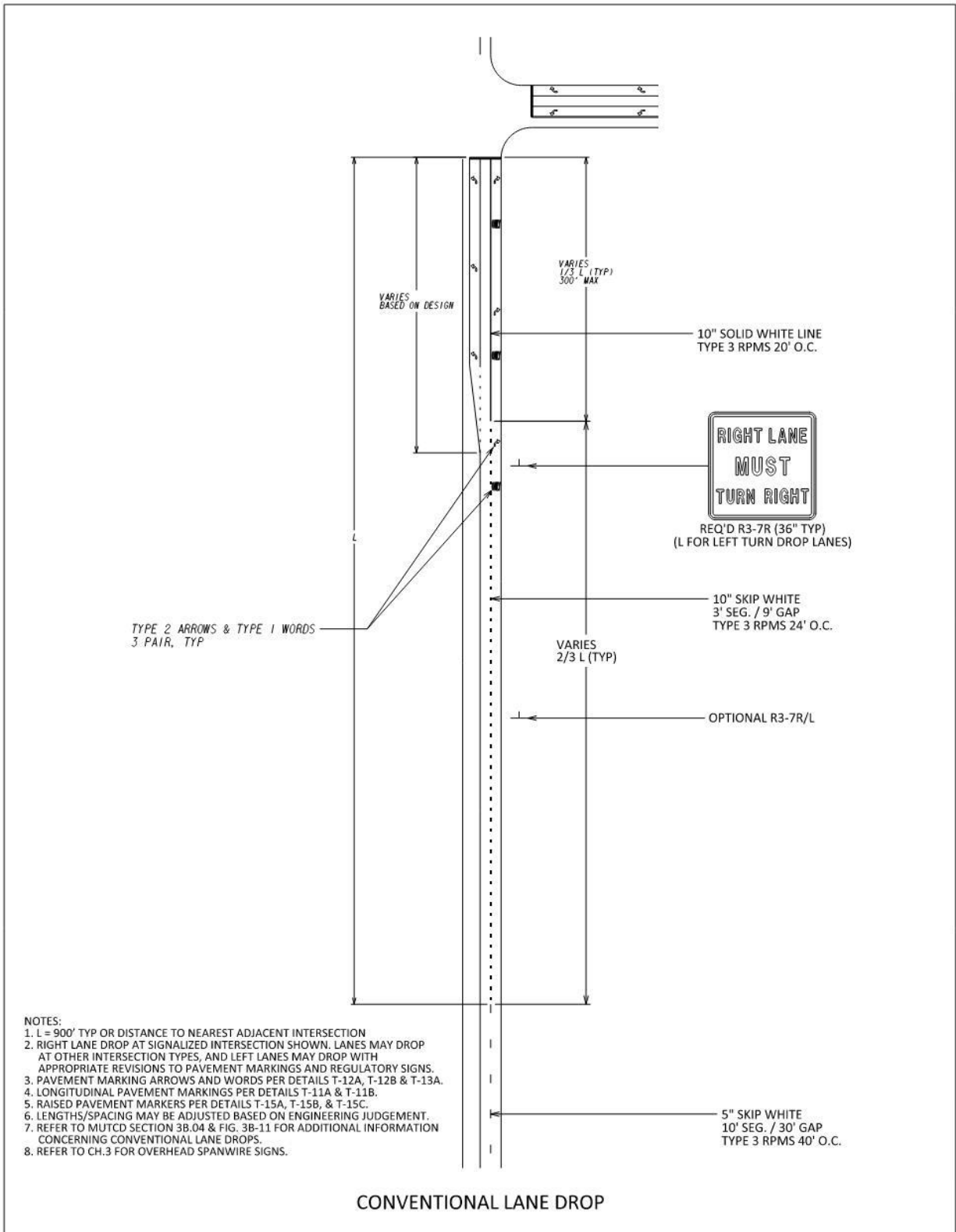
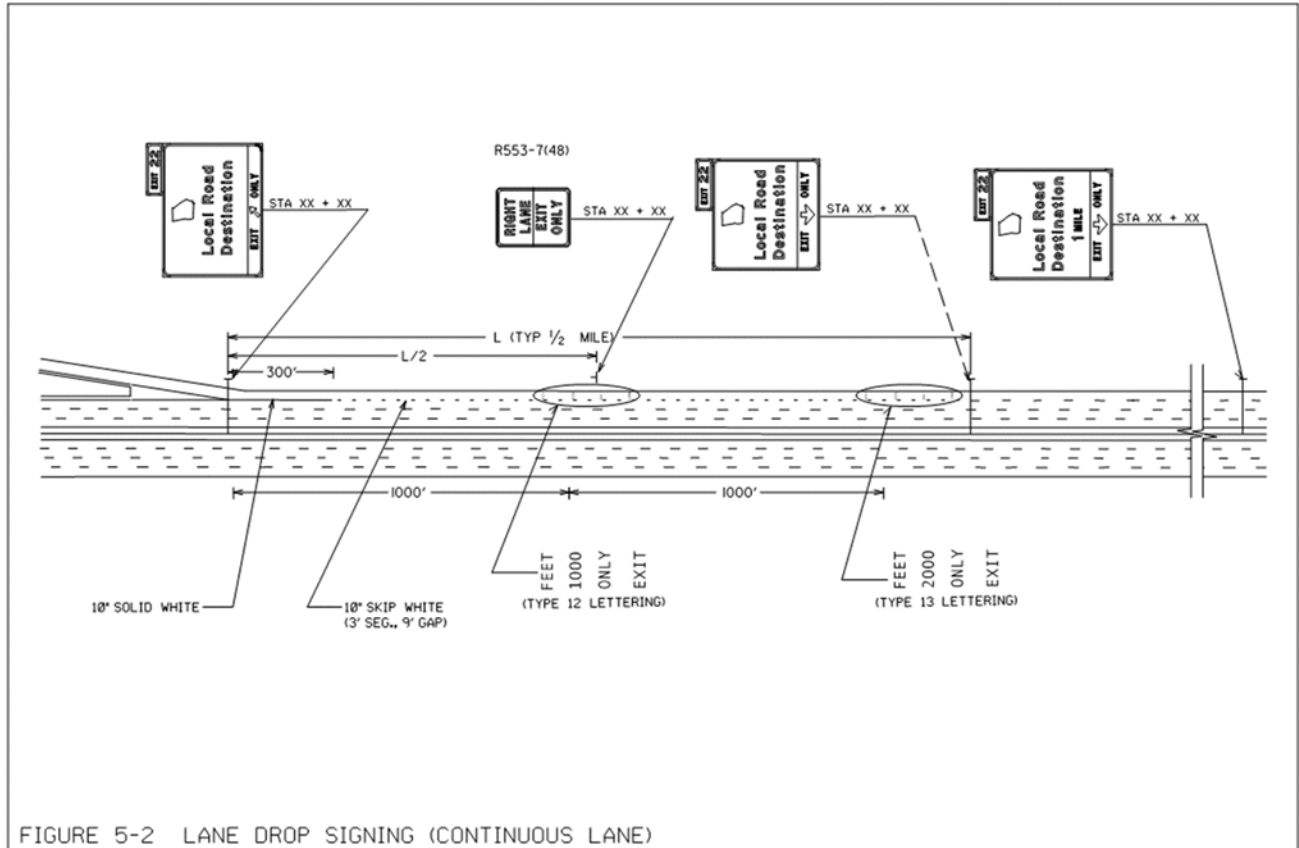

Figure 5-3C

5.4 Lane Drop – Continuous to Exit Lane

The lane drop – continuous to exit lane application is used for ending a lane as part of an exit where the lane has been continuous prior to the exit. [Figure 5-2](#) indicates the specific signs and the sign and pavement marking spacing required. The only sign required other than the exit signing is the R3-8 Sign.



5.5 Lane Drop – Auxiliary Lane

The lane drop – auxiliary lane application is used for ending a lane as part of an exit where the lane has not been continuous prior to the exit. [Figure 5-3](#) indicates the specific signs and the sign and pavement marking spacing required. The only sign required other than the exit signing is the R3-8 Sign.

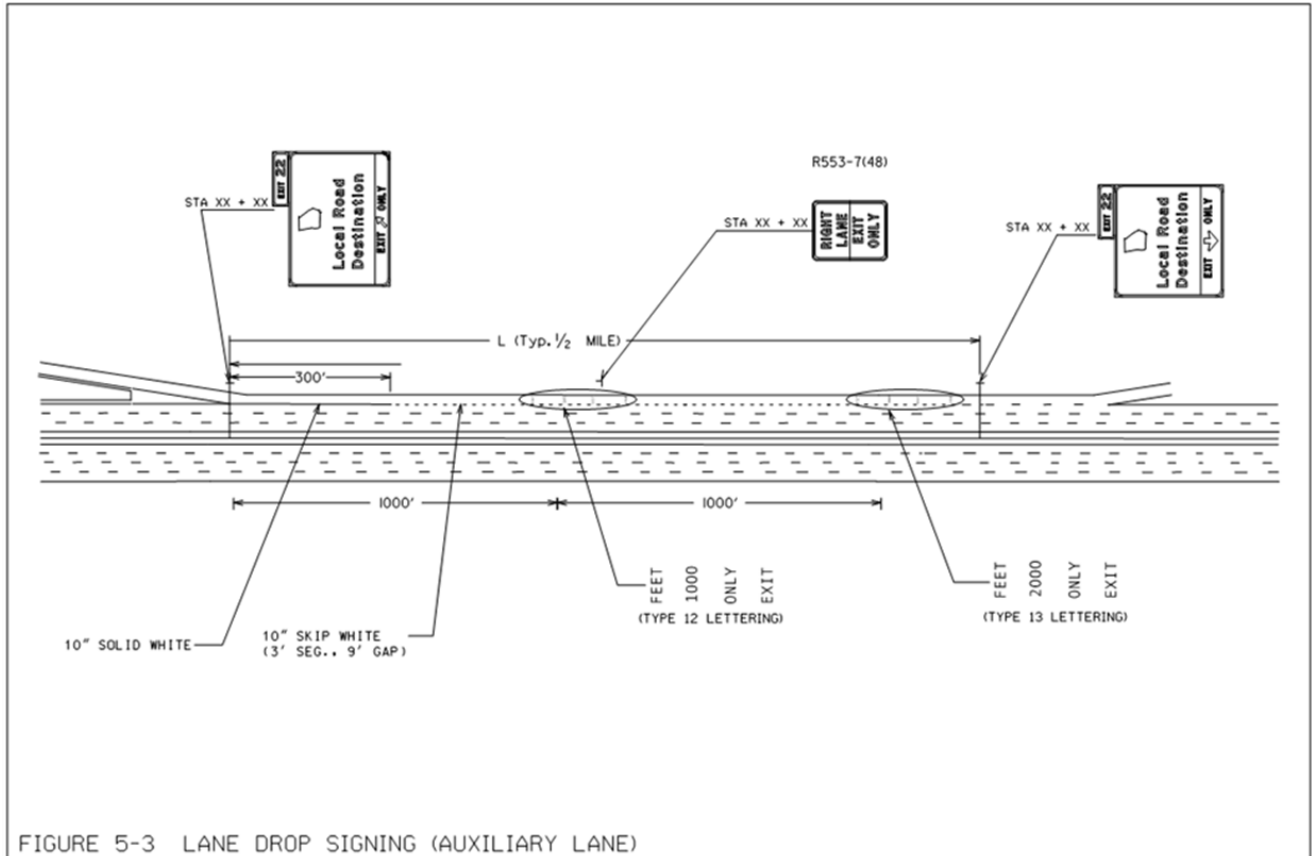

5.6 Lane Drop – Drop Option

The lane drop – drop option application is used for ending a lane as part of an exit when a second exit lane has the option of exiting. [Figure 5-4](#) indicates the specific signs required.

5.7 Lane Drop – Drop Option Auxiliary Lane

The lane drop – auxiliary lane application is used for ending a lane as part of an exit where the lane has not been continuous prior to the exit and a second exit lane has the option of exiting.

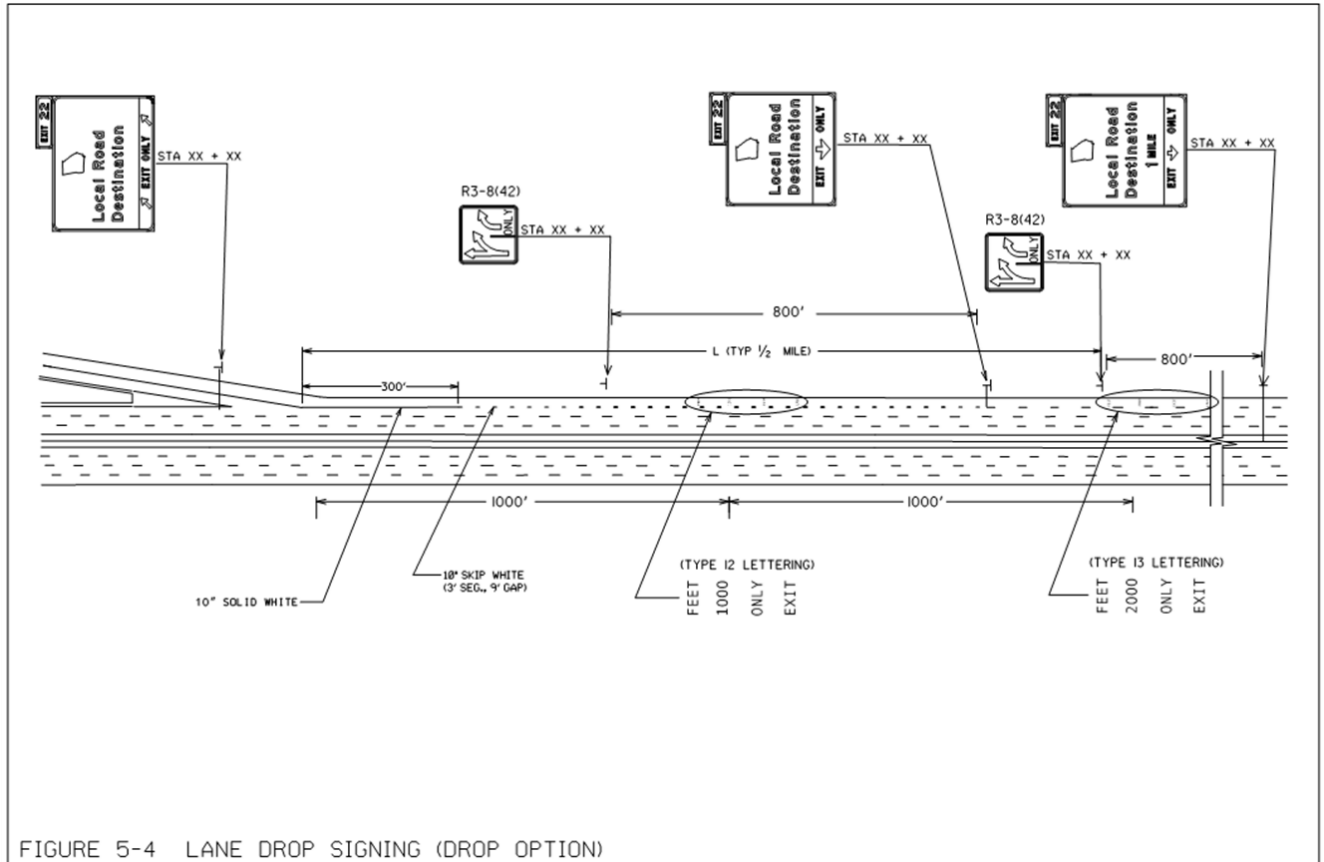

Chapter 6. Standard Signs - Contents

Chapter 6. Standard Signs - Contents	6-i
6.1 General.....	6-1

Chapter 6. Standard Signs

6.1 General

Standard signs are mounted on square tube sign posts (Type 7, Type 8, or Type 9). [Figure 4-5](#), [Figure 4-6](#), and [Figure 6-1](#) show the details of Georgia-specific signs.

The area (square footage) of the sign determines the type of sign material that is used for each sign. If the area exceeds 9 square feet, Type 2 sign material is required. For any sign with an area less than or equal to 9 square feet, Type 1 sign material may be used.

Design plans must specify the number, type, length, and spacing of sign posts for standard signs. Detail T-03a provides a chart for the selection of the number and type of sign posts. To use the chart, the width, height, area, and mounting height of the sign must be known. Details for mounting a single sign support are also shown on Detail T-03a. Detail T-02 shows the details for mounting signs using a breakaway support. Detail T-01 shows the standard signs and the mounting holes in the sign blanks.

The design plans identify the locations of standard signs to be installed with the station number, sign code, and sign template with no dimensions. No two signs shall have the same station number. The locations of standard signs that shall be removed are indicated by the sign template with no dimensions, the station number, and the note "REMOVE HIGHWAY SIGN, STANDARD X EACH." Existing standard signs that shall remain are shown with the sign template with no dimensions and the note "RETAIN IN PLACE."

The removal of signs is normally paid for as part of clearing and grubbing. If a sign is to be retained, the pay item to "Remove" the sign should be used and the sign replaced as new to ensure the current retro-reflectivity sheeting and latest design layout is used.

Examples of the summary of quantities sheets are provided in [Appendix D](#).

Examples of the general notes sheets are provided in [Appendix E](#).

Intentionally Left Blank

Chapter 7. Sign Layouts for Special Roadside and Overhead Highway Signs - Contents

Chapter 7. Sign Layouts for Special Roadside and Overhead Highway Signs - Contents	7-i
7.1 General.....	7-1

Chapter 7. Sign Layouts for Special Roadside and Overhead Highway Signs

7.1 General

Sign detail layouts are provided for specific applications. The length of the legend should be calculated for each sign by using the most recent GDOT-approved software. Sign measurements shall be in 6-inch increments.

Table 7-1 shows the border and radius requirements for all sign layouts.

Table 7-1: Border and Radius Requirements

Sign Height	Less than 3'-0"	3'-0" to 5'-0"	5'-6" to 7'-0"	Greater than 7'-0"	D1-5 Signs
Border	1.25"	1.25"	*1.25"	2"	1"
Radius	3"	6"	9"	12"	6"

*Signs 5'-6" to 7'-0" in height with 10" or 12" capital letters or 13.33" upper case/10" lower case and greater letters shall have 2" borders.

Sign layouts for specific signs are detailed in figures as shown below.

Code	Sign Legend	Figure
R554-5	NO TRUCKS OVER 6 WHEELS ALLOWED IN LEFT LANE	7-1
R554-11	ALL THRU TRUCKS OVER 6 WHEELS MUST USE I-285	4-4
	RIDESHARE	7-2
R554-X	NO TRUCKS OVER 6 WHEELS ALLOWED IN X LEFT LANES	7-1

Appendix A provides details and use of the layout. The signs are grouped by categories of advance exit signs, intermediate exit signs, exit signs, destination signs, and political boundary signs. This includes:

- Exit numbering – Numbered or unnumbered
- Mounting – Overhead or ground
- Sign sequence position – Advance, intermediate, or exit
- Exit lane arrangement – Normal, one lane continuous, one lane continuous with an optional lane, two or more lanes continuous
- Number of destination lines on the sign – One, two, or three
- Exit route shields and directions – Interstate shield, U.S. or Georgia route shield, cardinal directions

Intentionally Left Blank

Chapter 8. Special Roadside Signs Interstates/Freeways - Contents

Chapter 8. Special Roadside Signs Interstates/Freeways- Contents	8-i
8.1 General.....	8-1
8.2 Placement.....	8-3

Chapter 8. Special Roadside Signs Interstates/Freeways

8.1 General

Special roadside signs are ground-mounted signs that require extruded aluminum panels. Typical special roadside signs include destination signs, political boundary signs, exit gore signs, and supplemental guide signs. Use [Detail T-3B](#) to select the proper square tube posts and footings. Advanced exit signs and exit signs are also classified as special roadside signs if the facility is two lanes or less.

The height, width, and cross section of the sign are used to calculate the foundation and structural shape posts needed. The information can be calculated by using current GDOT standards referenced as:

[#9054A](#): Erection and Foundation Details for Special Roadside Signs, Breakaway Type Posts

[#9054B](#): Erection and Foundation Details for Special Roadside Signs, Breakaway Type Posts

[#9054C](#): Erection and Foundation Details for Special Roadside Signs, Breakaway Type Posts

Only structural steel shape or square tube posts shall be used. The post length is a function of the height of the sign and the cross-section slope. Standard 9054A indicates that the bottom of the sign should be at least 7 feet above the outside normal edge of pavement. In addition, no portion of the sign shall be less than 2 foot above the ground.

Special roadside signs with structural shape posts have a foundation that requires concrete. The amount of concrete is dependent on the foundation type, post size(s), and depth of the foundation. Table 8-1 provides calculations for the amount of concrete. D is the depth of the footing.

The locations of special roadside signs to be installed are identified on the plans with the station number, special sign number, and sign template with overall sign dimensions. The special sign number is a unique number assigned to all special roadside signs that are removed or installed. This number is in station order and requires that all signs with the same size and legend have the same number. The sign number is unique to each type of sign. Special roadside signs are defined with a two-digit number.

Table 8-1: Class A Concrete for Special Roadside Signs

TYPE 1 FOOTING

D (ft)	Concrete (ft³)	D (ft)	Concrete (ft³)	D (ft)	Concrete (ft³)
3'-0"	5.3013	8'-3"	14.5785	13'-3"	23.4140
3'-3"	5.7430	8'-6"	15.0203	13'-6"	23.8558
3'-6"	6.1848	8'-9"	15.4621	13'-9"	24.2976
3'-9"	6.6266	9'-0"	15.9039	14'-0"	24.7394
4'-0"	7.0684	9'-3"	16.3456	14'-3"	25.1811
4'-3"	7.5101	9'-6"	16.7874	14'-6"	25.6229
4'-6"	7.9519	9'-9"	17.2292	14'-9"	26.0647
4'-9"	8.3937	10'-0"	17.6710	15'-0"	26.5065
5'-0"	8.8355	10'-3"	18.1127	15'-3"	26.9482
5'-3"	9.2772	10'-6"	18.5545	15'-6"	27.3901
5'-6"	9.7190	10'-9"	18.9963	15'-9"	29.8318
5'-9"	10.1608	11'-0"	19.4381	16'-0"	28.2736
6'-0"	10.6026	11'-3"	19.8798	16'-3"	28.7153
6'-3"	11.0443	11'-6"	20.3216	16'-6"	29.1571
6'-6"	11.4861	11'-9"	20.7634	16'-9"	29.5989
6'-9"	11.9279	12'-0"	21.2052	17'-0"	30.0407
7'-0"	12.3697	12'-3"	21.6469	17'-3"	30.4824
7'-3"	12.8114	12'-6"	22.0887	17'-6"	30.9242
7'-6"	13.2532	12'-9"	22.5305	17'-9"	31.3660
7'-9"	13.6950	13'-0"	22.9723	18'-0"	31.8078
8'-0"	14.1368				

Deduct concrete for post sizes below from D values above for Type 1 footings.

Post Size	Concrete (ft³)	Post Size	Concrete (ft³)
S3x5.7	0.0138	W8x18	0.0780
S4x7.7	0.0185	W8x21	0.1139
W6x9	0.0304	W10x22	0.1200
W6x12	0.0428	W10x26	0.1424
W6x15	0.0721	W12x26	0.1545

TYPE 3 FOOTING

Post Size	Concrete (ft ³)	Post Size	Concrete (ft ³)
S3x5.7	20.7347	W8x18	28.0343
S4x7.7	20.7302	W8x21	31.8265
W6x9	24.5478	W10x22	31.8204
W6x12	24.5352	W10x26	31.7075
W6x15	28.0402	W12x26	31.7859

8.2 Placement

The locations of special roadside signs to be removed are shown on the plans with the station number, sign template with no dimensions, special sign number, and the following note: “REMOVE HIGHWAY SIGN SPECIAL ROADSIDE, X EACH,” where X is the number of signs to be removed. Special roadside signs that shall be left are noted with “RETAIN IN PLACE.”

The following are common pay items associated with special roadside signs:

Item No.	Description	Unit
500-3101	CLASS A CONCRETE	CY
610-6520	REM HIGHWAY SIGN, SPCL ROADSIDE	EA
633-3500	REMOUNT UNMODIFIED HIGHWAY SIGN, SPCL ROADSIDE	EA
636-1077	HIGHWAY SIGNS, ALUM EXTRUDED PANELS, REFL SHEETING, TP 9	SF
636-2080	GALV STEEL POSTS, TP 8	LF
636-2090	GALV STEEL POSTS, TP 9	LF
636-3000	GALV STEEL STR SHAPE POST	LB
636-9094	PILING IN PLACE, SIGNS, STEEL H, HP 12 X 53	LF

Each special roadside sign to be installed requires a layout showing the details of that sign with all of the dimensions. These are provided on Details of Special Roadside Signs sheet(s). The [Special Roadside Signs General Notes](#) are required.

- An example of the [Summary of Quantities for Special Roadside Signs](#) to be installed sheet and [Summary of Quantities, Remove and Remount Special Roadside Signs](#) is provided in Appendix D.

Intentionally Left Blank

Chapter 9. Overhead Highway Signs/Structures - Contents

Chapter 9. Overhead Highway Signs/Structures - Contents.....	9-i
9.1 General.....	9-1
9.2 Placement.....	9-1

Chapter 9. Overhead Highway Signs/Structures

9.1 General

Overhead highway signs are signs that are mounted over the roadway on overhead highway sign structures. All advance exit signs and exit signs on facilities that have three lanes or more in one direction shall be installed overhead. In addition, the “no trucks over six wheels in left X lane(s)” sign (R554-X, [Figure 7-1](#)) is mounted on bridges or other structures as an overhead sign. Refer to section 4.15.

Approval from the State Bridge Design Engineer is required before attaching sign(s) to a bridge.

9.2 Placement

Advance exit signs may be mounted on Type I, Type III, or Type VII sign structures. Type I or Type VII structures are required if the advance exit sign is for an exit-only lane. Type I structures are required for all signs that contain arrows. All structures require barrier or guardrail protection.

All interstates with three or more lanes in each direction require overhead guide signs. All interstates with four or more lanes in the direction of travel require guide signs to be placed over the travel lane.

Each overhead sign requires a clearance diagram that indicates the relative position of each sign and the position of the structure with relationship to the roadway cross section. The clearance diagram also indicates the layout of each overhead sign, including all dimensions. Type I structures require that the entire width of the roadway be shown with future signs. See [Section 10](#) for more information on clearance diagrams.

All overhead signs on a single structure should be the same height with the exception of general information or regulatory signs such as Rest Area or an R554-X. A minimum 1-foot horizontal spacing shall be maintained between each sign.

The locations of overhead signs to be installed are identified on the plans with the station number or mile post, special overhead sign number, sign template with overall sign dimensions, and a note indicating the structural support number and structure type. The special overhead sign number is a unique number assigned in station order to each special overhead sign that is removed or installed. If the sign is removed with the sign structure, then no special overhead sign number is assigned. The sequence of sign numbers for overhead signs should begin with a sequence that is not used by the special roadside signs. For example, if there are less than 100 numbered special roadside signs, the overhead sign numbers should begin with 101.

The structural support number combines an alphabetic code for the direction and facility with the milepost location in tenths of a mile. See [Figure 9-1](#) for Overhead Sign Structure Numbering. For example, I-95 southbound uses the alphabetic code of HH, so an overhead structure located at milepost 67.5 on I-95 southbound becomes structure number HH0675. The note for the location of new overhead signs and structure should be “STRUCTURAL SUPPORT #XXXX TYPE Z STRUCTURE REQUIRED,” where X = alphabetic code for facility and direction, YYY = milepost location in tenths of a mile, and Z = type of overhead sign structure.

The locations of overhead signs to be removed as part of a sign structure are shown on the plans with the station number, sign template with no dimensions, and the following note: “REMOVE STRUCTURAL SUPPORT #XYYYY, TYPE Z – LUMP.”

Removal shall include the following:

- Removing structure, complete, from STA. AAAA+AA, I-BB CBL (including removal of concrete footing to a depth of 1 foot below the existing ground line)
- Disposing of sign and structure by the contractor, unless specified otherwise in the plans.

Where:

X – Alphabetic code for the interstate facility and direction

Y – Milepost for the location in tenths of a mile

Z – Overhead sign structure type

A – Station number

B – Number of the interstate facility

C – Cardinal direction of the facility

The following are common pay items associated with overhead signs and structures.

Item No.	Description	Unit
610-6510	REM HWY SIGN, OVHD	EA
610-9401	REM STR SUPPORT, TYPE 1, , STA - AAAA + BB	LUMP
610-9402	REM STR SUPPORT, TYPE 2, , STA - AAAA + BB	LUMP
610-9403	REM STR SUPPORT, TYPE 3, , STA - AAAA + BB	LUMP
610-9407	REM STR SUPPORT, TYPE 7, , STA - AAAA + BB	LUMP
633-3000	REMOUNT UNMODIFIED HIGHWAY SIGN, OVERHEAD	EA
636-1080	HIGHWAY SIGNS, ALUM EXTRUDED PANELS, REFL SHEETING, TP 11	SF
636-1081	HIGHWAY SIGNS, ALUM EXTRUDED PANELS, REFL SHEETING, TP 11 INCLUDING BRACKETS	SF
638-1001	STR SUPPORT FOR OVERHEAD SIGN, TP I, STA - AAAA + BB	LUMP
638-1003	STR SUPPORT FOR OVERHEAD SIGN, TP III, STA - AAAA + BB	LUMP
638-1007	STR SUPPORT FOR OVERHEAD SIGN, TP VII, STA - AAAA + BB	LUMP
641-1200	GUARDRAIL, TP W	LF
641-5001	GUARDRAIL ANCHORAGE, TP 1	EA
641-5012	GUARDRAIL ANCHORAGE, TP 12	EA

An example of the [Summary of Quantities for Overhead Highway Signs](#) is provided in Appendix D.

Chapter 10. Clearance Diagrams for Overhead Signs - Contents

Chapter 10. Clearance Diagrams for Overhead Signs - Contents	10-i
10.1 General.....	10-1
10.2 Design Elements	10-1

Chapter 10. Clearance Diagrams for Overhead Signs

10.1 General

Clearance diagrams are required for all overhead signs. The length of the legend should be calculated for each sign using the current GDOT-approved software. Sign height measurements shall be in 6-inch increments and width measurements shall be in 1-inch measurements.

10.2 Design Elements

Critical elements on the clearance diagrams are:

- Project Number
- The location of existing guardrail or barrier wall
- The cross section of the roadway and shoulders, including the widths of paved surfaces
- The location of any proposed guardrail or median barrier to protect sign structures within the clear area that are not of breakaway construction
- The horizontal and vertical location of the signs in relation to the cross section of the roadway and lanes
- The structural support number and station number
- The sign design layout
- The design sign area (sq. ft.) for the **existing** structure.
- The design sign area (sq. ft.) for the **proposed** structure.
- The location of any footings for the sign structure
- Structure Type
- Bridge Name and Number for Type VII Bridge Attachments

The location of existing guardrail is indicated on the clearance diagram by the note "EXISTING GUARDRAIL." The location of existing guardrail or barrier should be shown for all roadways within the clear zone of the proposed structure, including frontage roads and in medians.

Existing guardrail should be verified to meet current standards.

An example of a clearance diagram for a Type I structure is shown on [Figure 10-1](#). New Type I structures shall be designed to accommodate maximum loading. The maximum loading (sq. ft.) can be calculated by multiplying the width of the roadway plus half of each shoulder by maximum height of 22 feet. Maximum loading shall be included in the Design Data table as Design Sign Area on the clearance diagrams. [Figure 10-2](#) shows an example of a clearance diagram for a Type III structure. The maximum sign width shall be 25 feet for Type III structures. [Figure 10-3](#) is an example of a clearance diagram for a Type I structure with a concrete median barrier. [Figure 10-4](#) is an example of a clearance diagram for a Type VII structure.

The placement of guardrail and barrier wall must also be shown on the plan view of the plans. The placement must be in accordance with GDOT standards. The GDOT standard for a median barrier is Standard 4940, CONCRETE BARRIER. Construction details for Type 26 and 26S median barriers with sign supports can be obtained by contacting the Office of Design Policy and Support.

The Overhead Highway Signs General Notes shall be included in Section 4 of the plan set.

Intentionally Left Blank

Chapter 11. Specific Service Signs (Logo Signs) - Contents

Chapter 11. Specific Service Signs (Logo Signs) - Contents..... 11-i
11.1 General.....11-1

Chapter 11. Specific Service Signs (Logo Signs)

11.1 General

The design and location of logo signs are not normal parts of an interstate signing project. The design and installation of logo signs are a function of Georgia Specific Service Signs, which designs, installs, and maintains these signs on the right-of-way. However, in the design of an interstate signing project, there may be conflicts with existing logo signs. As part of the interstate signing project, it is required that any logo signs that conflict with locations where a new sign is to be installed be moved and remounted. Relocation should be considered if a special roadside or overhead sign structure needs to be installed within 800 feet of the logo sign.

The GDOT Policies and Procedures (P & P) [6775-10](#), Standards for Signs Giving Specific Information – LOGO Business Signs, details the specific information on design and placement of logo signs. The relocation of any logo signing should be in accordance with this document. Relocation of one logo sign for an interchange may require moving other logo signs to provide for the sequence of 24-hour pharmacies, attractions, camping, lodging, food, and gas in the direction of travel.

An example of the [Summary of Quantities for Removing and Resetting Logo Signs](#) sheet is provided in Appendix D.

The following are common pay items associated with relocating logo signs.

Item No.	Description	Unit
610-9000	REM SIGN, STA -	LS
611-5550	RESET SIGN, STA -	LS

Designer/Contractor shall contact Georgia Logos, LLC 770-447-6399 or 1-800-783-2361 prior to the removal & replacement of LOGO signs. Replacement cost should be included in overall bid price. Existing signs shall remain during construction on a movable structure. New signs to be installed at proposed locations when construction activities conclude in the area.

Intentionally Left Blank

Chapter 12. Pavement Marking Designs Standards - Contents

Chapter 12. Pavement Marking Designs Standards - Contents	12-i
12.1 Materials	12-1
12.1.1 Pavement Marking Selection Chart	12-1
12.2 Pavement Markings	12-2
12.2.1 Edge lines	12-2
12.2.2 Bicycle Lanes	12-2
12.2.3 Crosswalks	12-2
12.2.4 Borders	12-2
12.2.5 Pavement Marking “ONLY”	12-2
12.2.6 Pavement Marking Arrows	12-3
12.2.7 Pavement Marking Shields	12-3
12.3 Raised Pavement Markers	12-3
12.4 Guidance on Marking Crosswalks	12-3
12.4.1 Controlled Intersections:	12-3
12.4.2 Uncontrolled Intersections:	12-4
12.5 Two-Stage Crossing	12-4

Chapter 12. Pavement Marking Designs Standards

12.1 Materials

Pavement marking material on asphalt is typically thermoplastic (preferred) or paint; however, other materials with contrast should be used on bridges and all other concrete surfaces. Widths for longitudinal lines, hatching, and stop bars are defined in the [GDOT Signing and Marking Details](#). Striping shall be offset two (2) inches from the longitudinal joint. Pavement marking material should conform to [Policies and Procedures \(P&P\) 6146-2](#) for maintenance activities.

12.1.1 Pavement Marking Selection Chart

It is the policy of the Georgia Department of Transportation to place and maintain pavement markings on the State Highway and Interstate Systems in accordance with the Manual of Uniform Traffic Control Devices. This policy governs the selection and use of pavement marking materials for construction and maintenance projects on fresh pavement. See Material Compatibility Matrix to determine whether recommended materials can be used over existing markings.

AADT	Asphalt			Concrete*		
	2 Lanes	>2 Lanes	Interstate/ Freeway	2 Lanes	>2 Lanes	Interstate /Freeway
<8,000	HT, H or T	HT, H or T		HT, F or P	HT, F or P	
8,000 ≥ n <15,000	HT or T	HT or T	HT or T	HT, F or P	HT, F or P	HT, F or P
≥15,000	HT, H or T	HT, H or T	HT or T	HT, F or P	HT, F or P	HT, F or P

H – Paint Traffic Stripe (652),
T – Thermoplastic Traffic Stripe (653),
F – Preformed Plastic Pavement Markings (657).
P – Polyurea Traffic Stripe (658)
HT – Hot Applied Preformed Plastic Pavement Marking (659)
M – Methyl Methacrylate
IP - Integrated Multi-polymer Pavement Marking Material

1. * Contrast markings shall be used for ALL lines on PCC surfaces (includes skip and edge lines). See Detail T-11B
2. * When a polymer overlay is present or high friction surface treatment is being used, thermoplastic should be used instead of preformed plastic.
3. Words and symbols shall be thermoplastic (653) or preformed material (657 & 659). Raised pavement markers (654) shall be used on all roadways in all categories.

12.2 Pavement Markings

12.2.1 Edge lines

Edge lines shall be placed on all paved roadways, including curb and gutter sections. When the width of a roadway with curb and gutter exceeds the normal distance from face of gutter to face of gutter for the number of travel lanes, the edge line shall be placed the appropriate distance from the centerline markings based on a lane width of 12 feet. Edge lines shall not be placed on roadways with curb and gutter if parallel or angle parking is permitted.

12.2.2 Bicycle Lanes

All pavement markings for bicycle lanes, including the edge line separating vehicular and bicycle traffic, shall be as specified in Detail [T-16](#). Type 1 arrows & Type 4 symbols shall be Hot Applied Preformed Thermoplastic. [Appendix C](#) contains examples of pavement markings for bicycle lanes.

12.2.3 Crosswalks

The design of crosswalks shall be in accordance with the GDOT [Specific details](#) and MUTCD standards. It is strongly preferred for crosswalk patterns to be striped per GDOT Detail [T-11A](#).

If a local government would like to stripe and maintain a crosswalk of a different pattern, it must at a minimum comply with MUTCD standards:

- All striping shall be white
- Solid white lines shall mark the crosswalk. Crosswalk lines shall not be less than 6 inches or greater than 24 inches in width.
- Either transverse or parallel lines shall be used; it is preferred by the Department for both transverse and parallel lines to be used.

Further, FHWA Ruling 3(09)-251 – Application of Colored Pavements – clearly describes acceptable and unacceptable color and pattern treatments for crosswalks. Local governments should refer to this ruling when considering designs that differ from Detail T11-1A. GDOT will assess any variations in crosswalk design in light of this ruling. GDOT is not in favor of crosswalks including graphics or elaborate designs.

The installation of crosswalks shall conform to the Crosswalk Guidance (Table 12-1, page 12-5) and shall be provided across paved public side roads where sidewalk exists. Contrast marking (black/white) shall be used on all concrete surfaces.

12.2.4 Borders

Borders around detail yellow striping and borders around detail white striping are included in the square yard pay item as indicated in the [Construction Detail](#) T-14. For pavement marking Detail A & B yellow & white the border is both sides of the hatching. For Detail C & D yellow & white the border is only on the travel lane side.

12.2.5 Pavement Marking “ONLY”

Pavement marking “ONLY” should be where a thru lane becomes a turn lane and where multiple adjacent left turn lanes exist as indicated in the [Construction Detail](#) T-12A.

12.2.6 Pavement Marking Arrows

Pavement marking arrows should be spaced every 100 feet (150 feet if “ONLY” words are used) as indicated in the [Construction Detail T-12A](#).

12.2.7 Pavement Marking Shields

Pavement marking shields, when used along interstates should coincide with the location of the advance guide signs which are typically placed 1/2, 1 and 2 miles in advance of the theoretical gore. Additional pavement marking shields may be used on a case-by-case basis, using sound engineering judgement. Along arterials and collectors, the pavement marking shields should be spaced similarly to pavement marking arrows. Please refer to GDOT Construction Detail [T-13D](#).

12.2.8 Lane Drop Striping

Longitudinal striping for a conventional lane drop at an intersection should be 10” wide. Refer to Chapter 5 & Figure 5-3C. Section 3B.04 in the MUTCD states that lane drop markings used in advance of lane drops at intersections should begin a distance in advance of the intersection that is determined by engineering judgment as suitable to enable drivers who do not desire to make the mandatory turn to move out of the lane being dropped prior to reaching the queue of vehicles that are waiting to make the turn.

12.3 Raised Pavement Markers

Raised pavement markers shall be provided in the design for all new roadways and on reconstruction where new pavement marking will be provided. The [GDOT Signing and Marking Details](#) referenced above describe each type of marker and provide guidelines for the location and spacing of raised pavement markers, [T-15A](#), [15B](#) & [15C](#).

12.4 Guidance on Marking Crosswalks

This guidance is intended to address the need to provide safer pedestrian crossings on Georgia’s roads. The guidance promotes engineering strategies to decrease pedestrian injuries and fatalities. Research indicates that simply marking a crosswalk does not necessarily improve pedestrian safety, and in some situations may decrease pedestrian safety. This guidance establishes the recommended pedestrian crossing treatment for various types of roadways. (Note that this section and table 12-1 only consider marked crosswalks; for additional guidance on other pedestrian countermeasures and when to consider them, refer to Table A-9 in the GDOT Pedestrian and Streetscape Guide.)

Guidance:

The following provisions for pedestrian facilities at intersections are recommended for Georgia DOT preconstruction and maintenance projects, commercial driveway, and access permits:

12.4.1 Controlled Intersections:

- a. At signalized intersections, marked crosswalks should be placed across all approaches that have adequate ADA and pedestrian accommodations/displays. Limited right-of-way and other limiting factors may not allow adequate pedestrian access.

- b. At all-way stops, marked crosswalks should be placed across all roads where there is sidewalk, or any evidence of pedestrian movement (such as worn paths on the roadside, transit stops, adjacent land uses that generate pedestrian trips – schools, parks, retail, dense residential development, etc).

12.4.2 Uncontrolled Intersections:

- a. At uncontrolled intersections * (including commercial driveways per GDOT Design Policy Manual section 7.4), where only the side road is required to stop or yield, marked crosswalks should be placed across all side roads where there is sidewalk, or any evidence of pedestrian movement (such as worn paths on the roadside, transit stops, adjacent land uses that generate pedestrian trips – schools, parks, retail, dense residential development, etc).
- b. At uncontrolled locations*, see Table 12-1, marked crosswalks and/or additional crossing enhancements should be placed across the state route or main route in accordance with Table 12-1.
- c. Marked crosswalks may be used at non-signalized street crossing locations in designated school zones to delineate preferred pedestrian paths across roadways. Use of adult crossing guards, school signs and markings, and/or traffic signals with pedestrian signals (when warranted) should be considered in conjunction with the marked crosswalk, as needed.
- d. Crosswalks and pedestrian crossing improvements at uncontrolled mid-block locations should be considered on a case-by-case basis based on sound engineering judgment or an engineering study.

Exceptions:

Crosswalks should not be installed at locations with poor sight distance, complex or confusing designs, or substantial heavy truck volume without first providing adequate design features and/or traffic control devices.

TABLE 12-1: Crosswalk Criteria

Roadway Type (number of Travel Lanes and Median Type)	Vehicle ADT ≤ 9,000			Vehicle ADT > 9,000 to 12,000			Vehicle ADT >12,000 to 15,000			Vehicle ADT >15,000		
	Speed Limit**											
	≤30 mph	35 mph	40 mph	≤30 mph	35 mph	40 mph	≤30 mph	35 mph	40 mph	≤30 mph	35 mph	40 mph
Two Lanes	C	C	P	C	C	P	C	C	N	C	P	N
Three Lanes	C	C	P	C	P	P	P	P	N	P	N	N
Multilane (four or more lanes) with raised median***	C	C	P	C	P	N	P	P	N	N	N	N
Multilane (four or more lanes) without raised median	C	P	N	P	P	N	N	N	N	N	N	N

* These guidelines include intersection and midblock locations with no traffic signals or stop signs on the approach to the crossing. They do not apply to school crossings. Crosswalks should not be installed at locations that could present an increased safety risk to pedestrians, such as where there is poor sight distance, complex or confusing designs, a substantial volume of heavy trucks, or other dangers, without first providing adequate design features and/or traffic control devices. Adding crosswalks alone will not make crossings safer, nor will they necessarily result in more vehicles stopping for pedestrians. Whether or not marked crosswalks are installed, it is important to consider other pedestrian facility enhancements (e.g., raised median, roadway narrowing, enhanced overhead lighting, curb extensions), as needed, to improve the safety of the crossing. These are general recommendations; good engineering judgment should be used in individual cases for deciding where to install crosswalks.

** Where the speed limit exceeds 64.4 km/h (40 mi/h), marked crosswalks alone should not be used at unsignalized locations.

*** The raised median or crossing island must be at least 1.2 m (4 ft) wide and 1.8 m (6 ft) long to serve adequately as a refuge area for pedestrians, in accordance with MUTCD and American Association of State Highway and Transportation Officials (AASHTO) guidelines.

C = Candidate sites for marked crosswalks. Marked crosswalks must be installed carefully and selectively. Before installing new marked crosswalks, an engineering study is needed to determine whether the location is suitable for a marked crosswalk. For an engineering study, a site review may be sufficient at some locations, while a more indepth study of pedestrian volume, vehicle speed, sight distance, vehicle mix, and other factors may be needed at other sites. It is recommended that a minimum utilization of 20 pedestrian crossings per peak hour (or 15 or more elderly and/or child pedestrians) be confirmed at a location before placing a high priority on the installation of a marked crosswalk alone.

P = Possible increase in pedestrian crash risk may occur if crosswalks are added without other pedestrian facility enhancements. These locations should be closely monitored and enhanced with other pedestrian crossing improvements, if necessary, before adding a marked crosswalk.

N = Marked crosswalks alone are insufficient, since pedestrian crash risk may be increased by providing marked crosswalks alone. Consider using other treatments or other substantial crossing improvement to improve crossing safety for pedestrians.

Table 12-2: Pavement Marking Types		
Pavement Marking Arrows		GDOT Detail #
TP 1 Arrow	Thru Movement	T-12B
TP 2 Arrow	Left/Right Turn Movement	
TP 2A Arrow	Left Turn with dot	
TP 3 Arrow	Thru + Left/Right Turn Movement	
TP 3A Arrow	Thru + Left Turn with dot	
TP 4 Arrow	Wrong Way Thru	
TP 5 Arrow	Left + Right Turn Movement	
TP 5A Arrow	Left + Right Turn with dot	
TP 6 Arrow	Left + U-Turn Movement	
TP 7 Arrow	U-Turn Movement	
TP 8 Arrow	Lane Reduction	
TP 9 Arrow	Within Mini-Roundabouts	
Pavement Marking Text		
TP 1 Word	"ONLY"	T-13A
TP 2 Word	"STOP"	
TP 3 Word	"SCHOOL"	
TP 4 Word	"AHEAD"	
TP 5 Word	"SLOW"	
TP 6 Word	"BUSES"	
TP 7 Word	"LANE ENDS"	T-13B, T-13C
TP 10 Word	"LANE ENDS 1000 FEET"	
TP 11 Word	"LANE ENDS 2000 FEET"	
TP 12 Word	"EXIT ONLY 1000 FEET"	
TP 13 Word	"EXIT ONLY 2000 FEET"	
TP 15 Word	"YIELD"	T-13A
TP 16 Word	"SIGNAL"	
TP 17 Word	"EXIT"	T-13B
TP 20 Word	"EXPRESS"	T-13A
TP 21 Word	"EAST"	T-13D
TP 22 Word	"WEST"	
TP 23 Word	"NORTH"	
TP 24 Word	"SOUTH"	
Pavement Marking Symbols		
TP 1 Symbol	HOV Diamond	T-17A
TP 4 Symbol	Bicycle	T-16
TP 5 Symbol	Interstate Shield	T-13D

Chapter 13. Roundabout Signing and Marking - Contents

Chapter 13. Roundabout Signing and Marking - Contents 13-i

13.1 General.....13-1

13.2 Signing.....13-1

 13.2.1 Advanced Warning Signs13-1

 13.2.2 Yield Sign13-1

 13.2.3 Guide Signs.....13-1

 13.2.4 Lane Use Signs13-2

 13.2.5 Other Signs13-2

13.3 Marking.....13-2

 13.3.1 Edge Line Extension13-2

 13.3.2 Lane Use13-2

 13.3.3 Multilane Pavement Markings13-2

 13.3.4 Pedestrian Crossings13-3

 13.3.5 Rumble Strips.....13-3

 13.3.6 Marking Materials13-3

 13.3.7 Guidance on Marking Crosswalks.....13-3

Chapter 13. Roundabout Signing and Marking

13.1 General

This chapter along with Chapter 4 of the [GDOT Roundabout Design Guide](#) provides standards and guidelines that must be used in the design of roundabout traffic signing and pavement markings prepared for the Georgia Department of Transportation (GDOT). All signs and markings provided in this chapter conform to the *Manual on Uniform Traffic Control Devices (MUTCD)* and the *National Cooperative Highway Research Program (NCHRP) Report 672 and 1043*.

13.2 Signing

13.2.1 Advanced Warning Signs

Advance roundabout warning signs with advisory speed plaques (W2-6 and W13-1P) are required on all high-speed approaches or when Yield signs are not readily visible. They are optional when the approach speed is 40 MPH or less. Refer to MUTCD, page 108, Table 2C-4, for placement of W2-6 signs.

13.2.2 Yield Sign

Yield signs R1-2 shall be placed on the right and left of the road at the point where vehicles are to yield when entering the roundabout. The right-side yield sign may also include underneath it the sign R559-1 (Refer to Fig. 4-7 in Appendix F) to help reinforce yielding to vehicles circulating. The left side yield sign may also include underneath it the sign R6-2 to help establish the traffic flow within the roundabout.

13.2.3 Guide Signs

- a. D1-5 guidance signs should be used along state route approaches and are recommended along county/city route approaches, except where posted speeds are below 40mph – in which D1-3d signs should be used. D1-5, diagrammatic style signs are especially preferred on rural high-speed roadways because they reinforce the form and the shape of the approaching intersection. Use D1-3d with minimum 6-inch letter heights when lateral space is limited.
- b. W16-8P and W16-8aP supplemental sign plaques may be used to supplement the W2-6 sign instead of a W16-9 supplemental plaque, specifically when a D1-5 sign will not be in use along the same approach.
- c. Exit guide signs with State Route/US Route shields (M-Series assembly or D1-1e signs) or street name signs (D1-1d) with a minimum text height of 6" should be placed on the splitter islands oriented toward traffic on the circulatory roadway. Flag-type guide signs indicating the correct directional exit for service, recreational and cultural destinations are required for major destination routes. (See Figure 2D-9, MUTCD 2009)

13.2.4 Lane Use Signs

Lane use R3-6 signs should be installed overhead on any multilane entry. If overhead R3-8 signs are infeasible then post mounted R3-8 signs should be used. R3-8 series signs should be modified to show the placement of a 'dot' under the left arrow of the leftmost lane; this graphically helps depict the lane usage to the driver in the left lane only. These signs should be installed on both sides of the roadway if possible, left side splitter lane and right side terrace.

Overhead lane use signs are encouraged over the ground-mounted signs. By giving lane use guidance to the motorist in advance allows them to be in the correct lane at the roundabout approached and discourages them from making a lane change with the roundabout. Signs may be repeated if necessary but no closer than the beginning of the solid line. Arrows style should match the pavement markings. Placement should be at the first set of pavement marking arrows.

13.2.5 Other Signs

Pedestrian signs should be placed in advance of the crosswalk. W11-2 shall be used for multilane roundabout approaches. An R4-7 sign shall be placed on nose point of splitter islands, 10' back from the face of curb. R6-4 Signs should be used within the central island of mini-roundabouts and R6-4B shall be used within the central island of single or multilane roundabouts.

13.3 Marking

13.3.1 Edge Line Extension

- a. Wide dotted white extension of the circulatory roadway edge line (commonly called a "yield line") must be 18" skip white (2' segment, 2' gap) and should be a straight line tangent to the outside edge of the circulatory roadway at the corner of the splitter island. 18" skip white should be used on asphalt and 24" skip white with contrast should be used on concrete.
- b. Yield triangles or "Shark's teeth" should not be used to mark the location at which drivers must yield.

13.3.2 Lane Use

Type 15 word "YIELD" pavement marking is required on all approaches located between the crosswalk and the yield bar. On multilane approaches, placement is duplicated in each lane.

Lane use pavement markings, including arrows and solid or dashed lines should be used on multilane roundabouts. Solid or dotted lines should be 8" wide along the roundabout approaches as well as within the circulatory roadway to deter lane changes. Audible thermoplastic striping is also an option within the circulatory roadway. For more information refer to Figures 3C-3 through 3C-14 of the 2009 MUTCD.

13.3.3 Multilane Pavement Markings

On all multilane approaches of a roundabout standard arrows with a dot to the left of the arrow for the left lane only, shall be used. Within the circulatory roadway, standard arrows should be used. See Figure 3C-2, MUTCD 2009.

13.3.4 Pedestrian Crossings

All pedestrian crossings shall be marked. Refer to Section 12.4 and [Construction Detail T-11A](#). For roundabout approaches with a single stage crossing proposed across multiple lanes, include conduit and pull boxes along approach for future pedestrian accommodations. (Refer to the PROWAG for additional information)

13.3.5 Rumble Strips

Rumble strips should be used in the following instances:

- Approaches with limited visibility
- Where the posted speed limit is 50 mph or greater

Rumble strips should be considered where there are high crash rates and are seen as a viable solution. Rumble strips should not be used in residential areas unless agreed upon by District Traffic Engineer. Refer to [Construction Detail T-19](#) for installation.

13.3.6 Marking Materials

Pavement marking material selection shall be based on AADT of the circulatory roadway. Refer to Section 12 for more information on Pavement Markings Designs Standards.

13.3.7 Guidance on Marking Crosswalks

Refer to Section 12.4 and Construction Detail T-11A.

Intentionally Left Blank

Appendix A. Index and Legend

INDEX

- A – 1 ADVANCE GUIDE SIGN
- A – 2 ADVANCE GUIDE SIGN WITH STATE SHIELD
- A – 3 ADVANCE GUIDE SIGN WITH INTERSTATE SHIELD
- A – 4 EXIT DIRECTION SIGN
- A – 5 EXIT DIRECTION SIGN WITH STATE SHIELD
- A – 6 EXIT DIRECTION SIGN WITH INTERSTATE SHIELD
- A – 7 ADVANCE LANE DROP SIGN
- A – 8 ADVANCE LANE DROP SIGN WITH STATE SHIELD
- A – 9 ADVANCE LANE DROP SIGN WITH INTERSTATE SHIELD
- A – 10 LANE DROP SIGN
- A – 11 LANE DROP SIGN WITH STATE SHIELD
- A – 12 ADVANCE LANE DROP SIGN WITH INTERSTATE SHIELD
- A – 13 SUPPLEMENTAL GUIDE SIGNS
- A – 14 INTERCHANGE SEQUENCE SIGNS

LEGEND

- R DETERMINED BY CENTERING: 18” MINIMUM IF GOVERNING LINE OF COPY
- S DETERMINED BY CENTERING: 8” MINIMUM IF GOVERNING LINE OF COPY
- T DETERMINED BY CENTERING: 24” MINIMUM IF GOVERNING LINE OF COPY
- U 13” MINIMUM
- V 15” MINIMUM
- W SIGN WIDTH (FEET & INCHES)
- X DETERMINED BY LENGTH OF DESTINATION NAME
- Y DETERMINED BY CENTERING: 15” MINIMUM AND 20” MAXIMUM IF GOVERNING LINE OF COPY
- Z DETERMINED BY CENTERING: 12” MINIMUM IF GOVERNING LINE OF COPY
- # DETERMINED BY LENGTH OF DISTANCE/CARDINAL DIRECTION LETTERING:

A - 1 ADVANCE GUIDE SIGNS - NO SCALE -

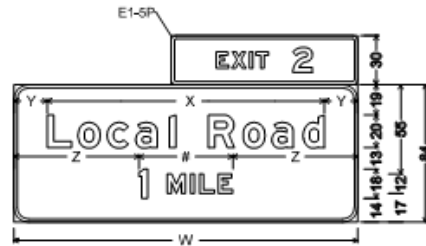

12" Radius, 2" Border, White on Green;
"Local Road" E Mod; "1 MILE" E Mod;

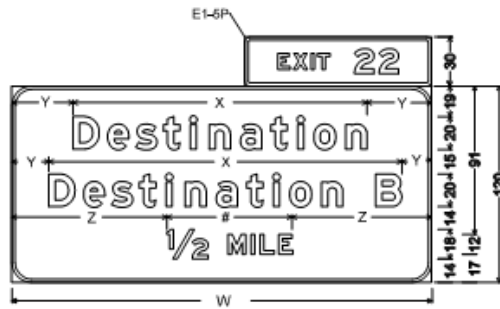

12" Radius, 2" Border, White on Green;
"Destination" E Mod; "Destination" E Mod;
" 1/2 MILE" E Mod;

Note: E1-5P is a Standard Highway Sign. Specific dimension information can be found in the Standard Highway Signs and Markings Book.

A - 2 ADVANCE GUIDE SIGNS - NO SCALE -

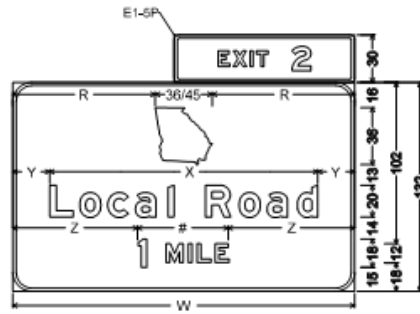

12" Radius, 2" Border, White on Green;
"Local Road" E Mod; "1 MILE" E Mod;

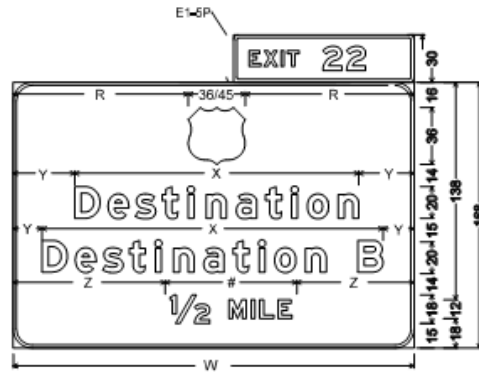

12" Radius, 2" Border, White on Green;
"Destination" E Mod; "Destination" E Mod;
"1/2 MILE" E Mod;

Note: E1-5P is a Standard Highway Sign. Specific dimension information can be found in the Standard Highway Signs and Markings Book.

A - 3 ADVANCE GUIDE SIGNS - NO SCALE -

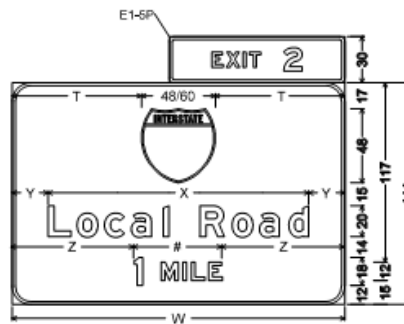

12" Radius, 2" Border, White on Green;
"Local Road" E Mod; "1 MILE" E Mod;

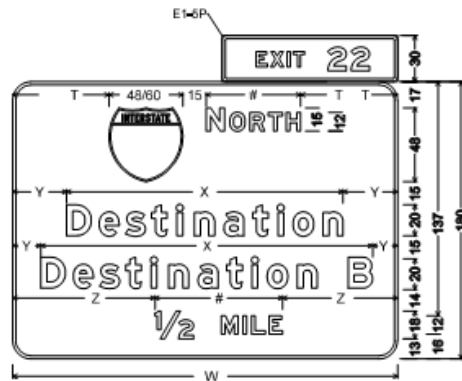

12" Radius, 2" Border, White on Green;
"NORTH" E Mod; "Destination" E Mod;
"Destination" E Mod; "1/2 MILE" E Mod;

Note: E1-5P is a Standard Highway Sign. Specific dimension information can be found in the Standard Highway Signs and Markings Book.

A - 4 EXIT DIRECTION SIGNS - NO SCALE -

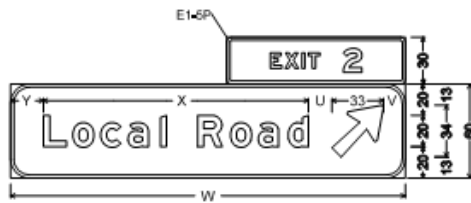

12" Radius, 2" Border, White on Green;
"Local Road" E Mod; Arrow 18 - ° 45°;

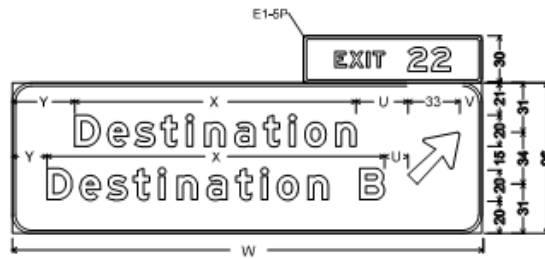

12" Radius, 2" Border, White on Green;
"Destination" E Mod; "Destination" E Mod; Arrow 18 - 42° 45°;

Note: E1-5P is a Standard Highway Sign. Specific dimension information can be found in the Standard Highway Signs and Markings Book.

A - 5 EXIT DIRECTION SIGNS - NO SCALE -

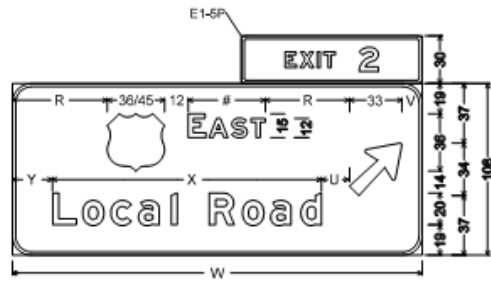

12" Radius, 2" Border, White on Green;
 "EAST" E Mod; "Local Road" E Mod; Arrow 18 - 42" 45";

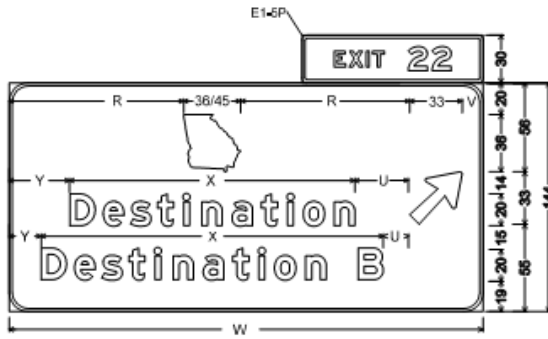

12" Radius, 2" Border, White on Green;
 "Destination" E Mod; "Destination" E Mod; Arrow 18 - 42" 45";

Note: E1-5P is a Standard Highway Sign. Specific dimension information can be found in the Standard Highway Signs and Markings Book.

A - 6 EXIT DIRECTION SIGNS - NO SCALE -

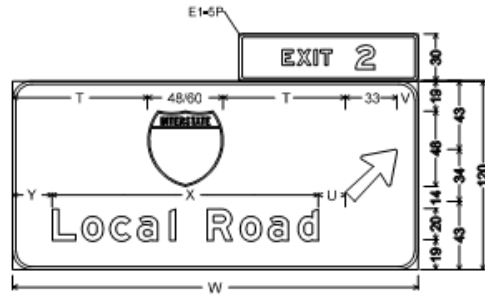

12" Radius, 2" Border, White on Green;
"Local Road" E Mod; Arrow 18 - 42" 45";

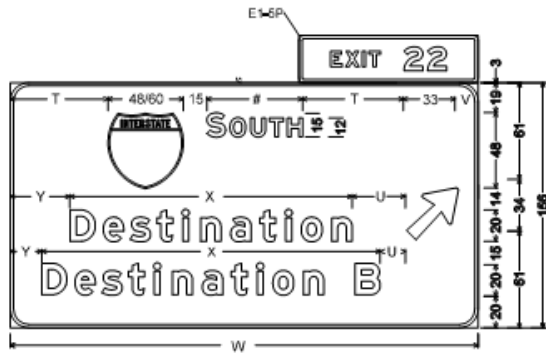

12" Radius, 2" Border, White on Green;
"SOUTH" E Mod; "Destination" E Mod; "Destination" E Mod;
Arrow 18 - 42" 45";

Note: E1-5P is a Standard Highway Sign. Specific dimension information can be found in the Standard Highway Signs and Markings Book.

A - 7 ADVANCE LANE DROP SIGNS - NO SCALE -

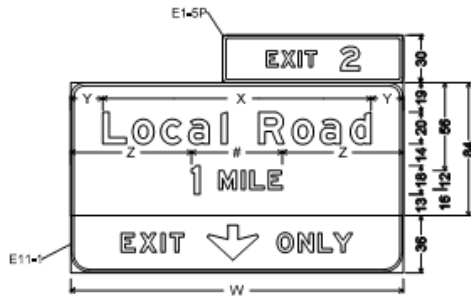

12" Radius, 2" Border, White on Green;
"Local Road" E Mod; "1 MILE" E Mod;

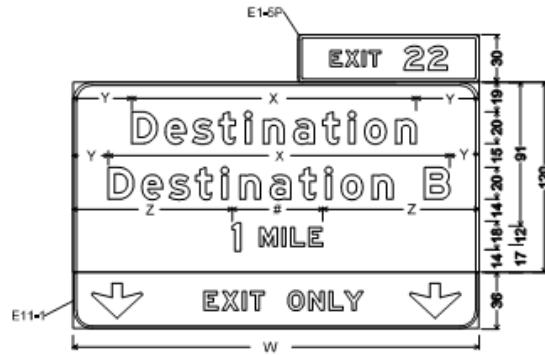

12" Radius, 2" Border, White on Green;
"Destination" E Mod; "Destination B" E Mod;
"1 MILE" E Mod;

Note: E1-5P and E11-1 are Standard Highway Signs. Specific dimension information can be found in the Standard Highway Signs and Markings Book.

A - 8 ADVANCE LANE DROP SIGNS - NO SCALE -

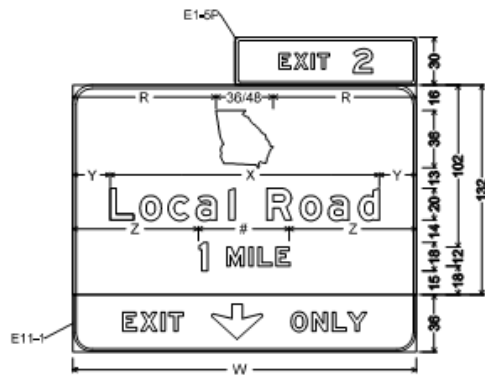

12" Radius, 2" Border, White on Green;
"Local Road" E Mod; "1 MILE" E Mod;



12" Radius, 2" Border, White on Green;
"Destination" E Mod; "Destination" E Mod;
"1 MILE" E Mod;

Note: E1-6P and E11-1 are Standard Highway Signs. Specific dimension information can be found in the Standard Highway Signs and Markings Book.

A - 9 ADVANCE LANE DROP SIGNS - NO SCALE -

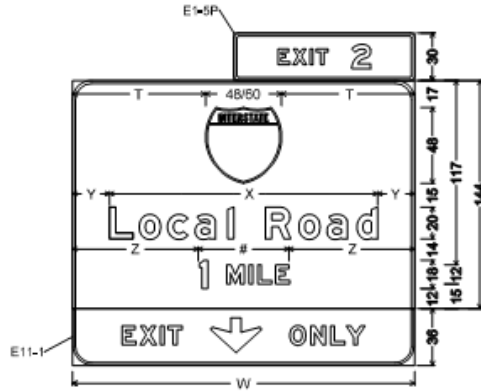

12" Radius, 2" Border, White on Green;
"Local Road" E Mod; "1 MILE" E Mod;

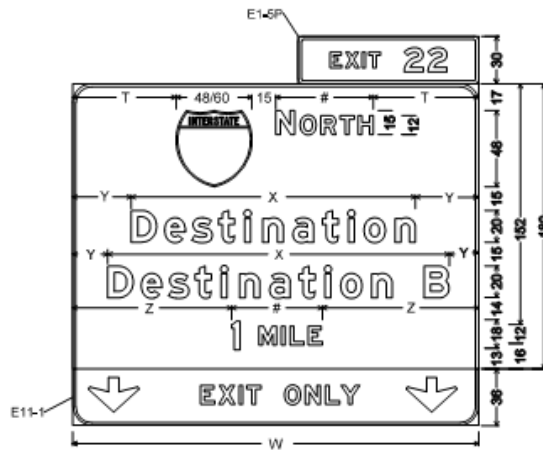

12" Radius, 2" Border, White on Green;
"NORTH" E Mod; "Destination" E Mod;
"Destination" E Mod; "1 MILE" E Mod;

Note: E1-5P and E11-1 are Standard Highway Signs. Specific dimension information can be found in the Standard Highway Signs and Markings Book.

A - 10 LANE DROP SIGNS - NO SCALE -

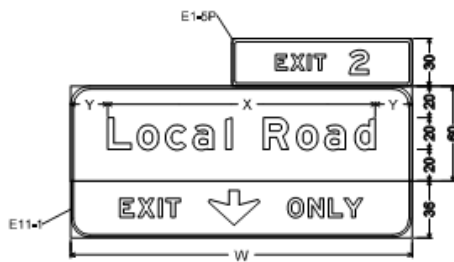

12" Radius, 2" Border, White on Green;
"Local Road" E Mod;

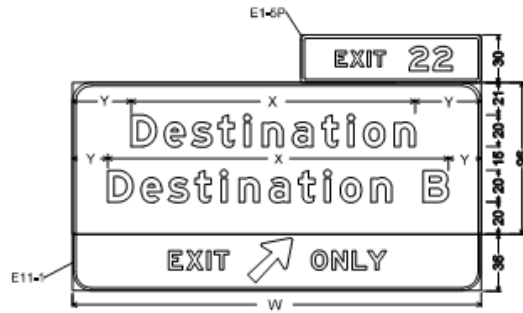

12" Radius, 2" Border, White on Green;
"Destination" E Mod; "Destination" E Mod;

Note: E1-6P and E11-1 are Standard Highway Signs. Specific dimension information can be found in the Standard Highway Signs and Markings Book.

A - 11 LANE DROP GUIDE SIGNS - NO SCALE -

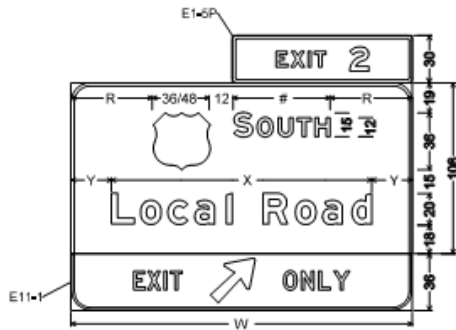

12" Radius, 2" Border, White on Green;
"SOUTH" E Mod; "Local Road" E Mod;

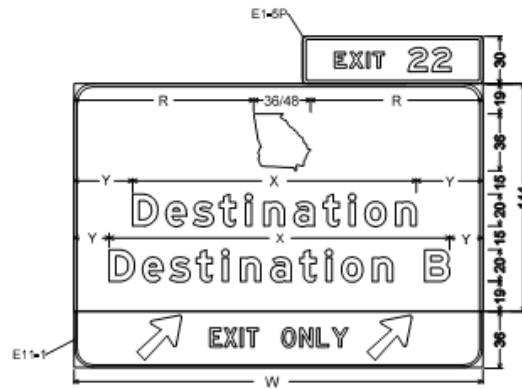

12" Radius, 2" Border, White on Green;
"Destination" E Mod; "Destination" E Mod;

Note: E1-5P and E11-1 are Standard Highway Signs. Speed & dimension information can be found in the Standard Highway Signs and Markings Book.

A - 12 DROP LANE GUIDE SIGNS - NO SCALE -

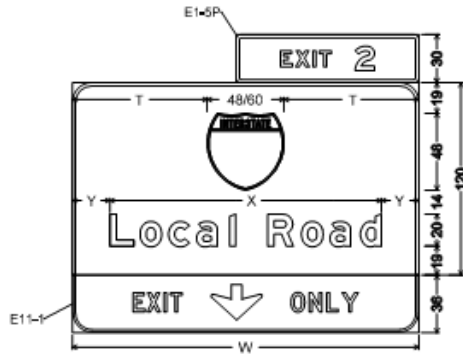

12" Radius, 2" Border, White on Green;
"Local Road" E Mod;

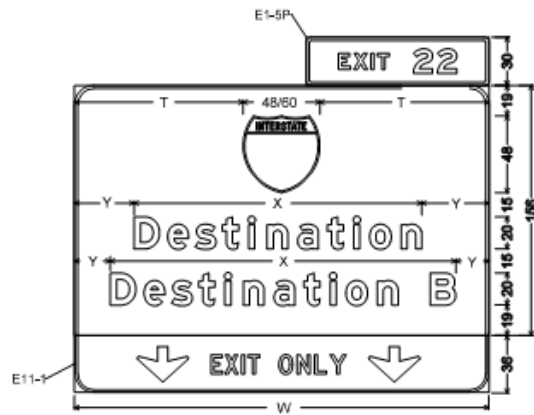

12" Radius, 2" Border, White on Green;
"Destination" E Mod; "Destination" E Mod;

Note: E1-5P and E11-1 are Standard Highway Signs. Specific dimension information can be found in the Standard Highway Signs and Markings Book.

A - 13
SUPPLEMENTAL GUIDE SIGNS
- NO SCALE -



9" Radius, 2" Border, White on Green;
"Destination" E Mod; "EXIT 222" E Mod;



9" Radius, 2" Border, White on Green;
"Destination" E Mod; "Destination" E Mod;
"EXIT 222" E Mod;

A - 14 INTERCHANGE SEQUENCE SIGNS - NO SCALE -

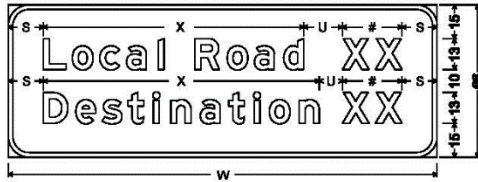

9" Radius, 2" Border, White on Green;
"Local Road" E Mod; "Destination" E Mod; "XX" E Mod;

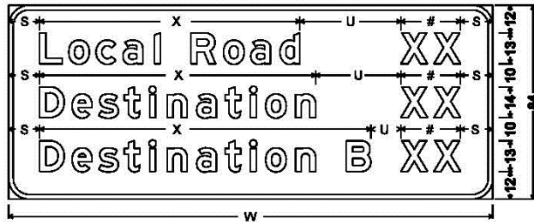

9" Radius, 2" Border, White on Green;
"Local Road" E Mod; "Destination" E Mod; "Destination B" E Mod;
"XX" E Mod

Intentionally Left Blank

Appendix B. Typical Signing and Pavement Marking

Figure B-1	Signing To/From Divided Highway
Figure B-2	Marking To/From Divided Highway
Figure B-3	Signing at a Closed Median “T” Intersection
Figure B-4	Marking at a Closed Median “T” Intersection
Figure B-5	Signing at RCUT Intersection
Figure B-8	Marking at RCUT Intersection
Figure B-9	Signing at a Type B Median Opening
Figure B-10	Signing at a Type B Median “T” Intersection
Figure B-11	Signs at a Type B Median Cross Road Intersection
Figure B-12	Marking at a Type B Median “T” Intersection
Figure B-13	Signing at a Type C Median Opening
Figure B-14	Signing at a Type C Median “T” Intersection
Figure B-15	Signing at a Type C Median Cross Road Intersection
Figure B-16	Marking at a Type C Median “T” Intersection
Figure B-17	School Zone Signing
Figure B-18	Stop Sign Placement Detail
Figure B-19	Typical Rural RPM Passing Detail

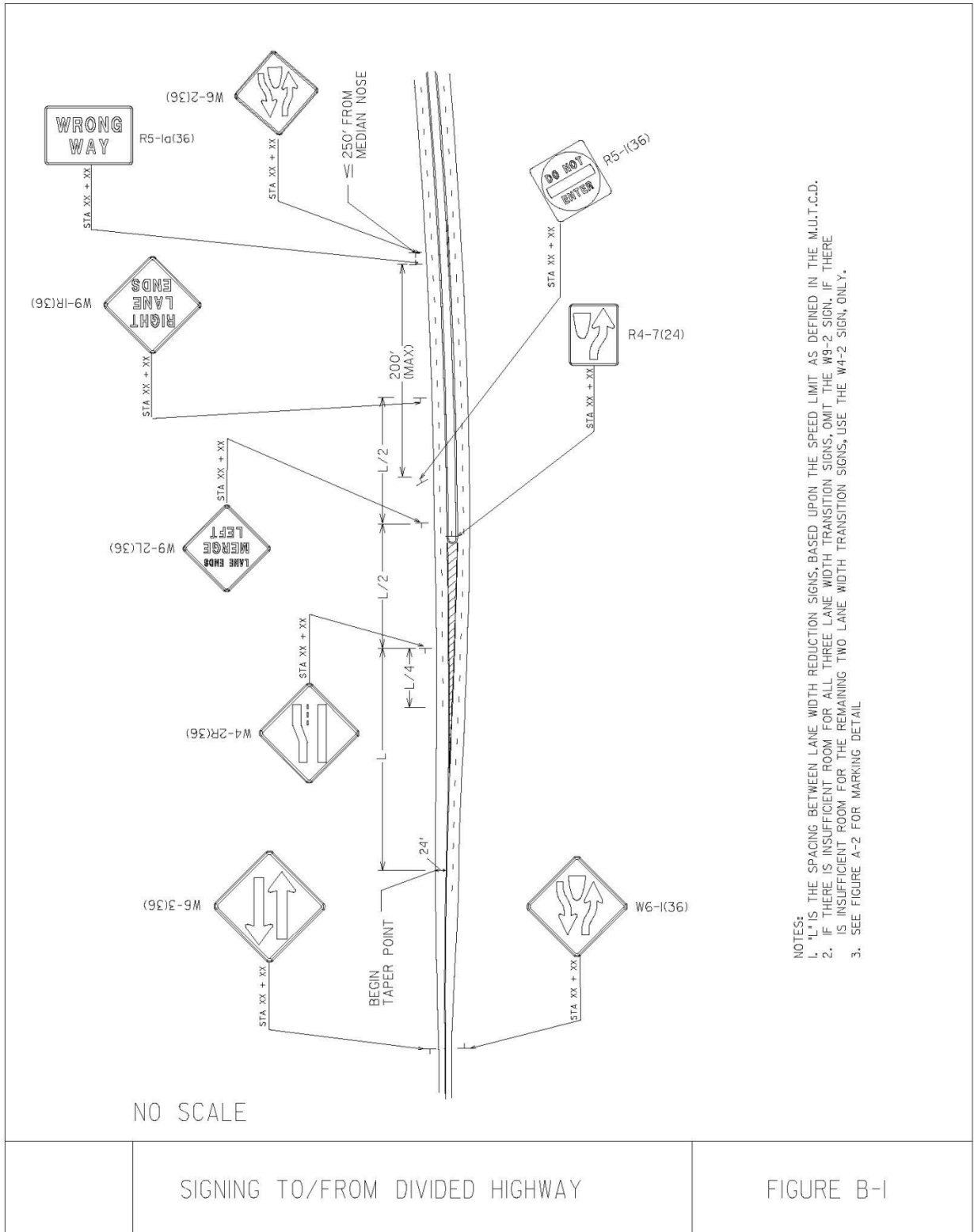

NOTES:
 1. 'L' IS THE SPACING BETWEEN LANE WIDTH REDUCTION SIGNS, BASED UPON THE SPEED LIMIT AS DEFINED IN THE M.U.T.C.D.
 2. IF THERE IS INSUFFICIENT ROOM FOR ALL THREE LANE WIDTH TRANSITION SIGNS, OMIT THE W9-2 SIGN. IF THERE IS INSUFFICIENT ROOM FOR THE REMAINING TWO LANE WIDTH TRANSITION SIGNS, USE THE W4-2 SIGN, ONLY.
 3. SEE FIGURE A-2 FOR MARKING DETAIL.

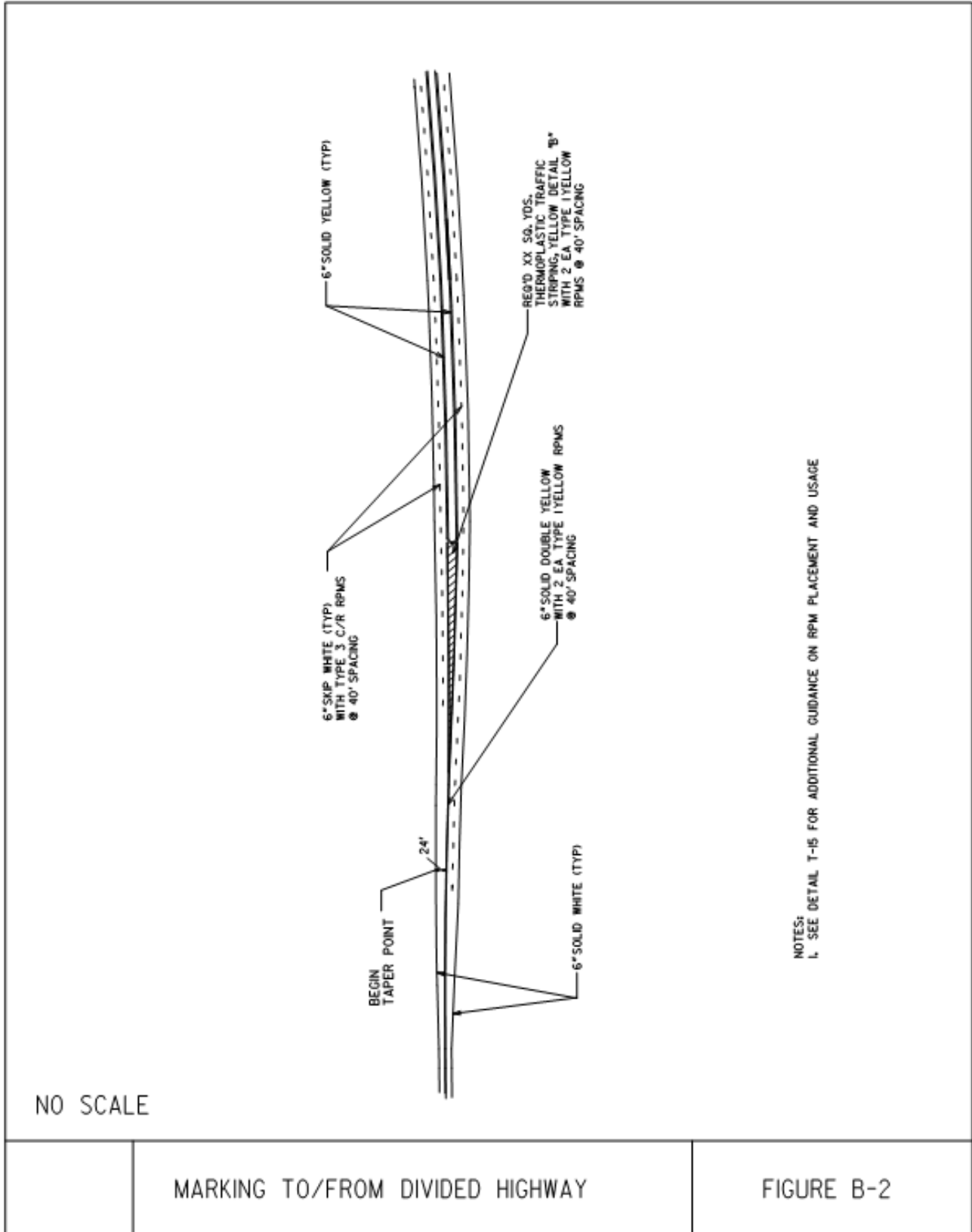

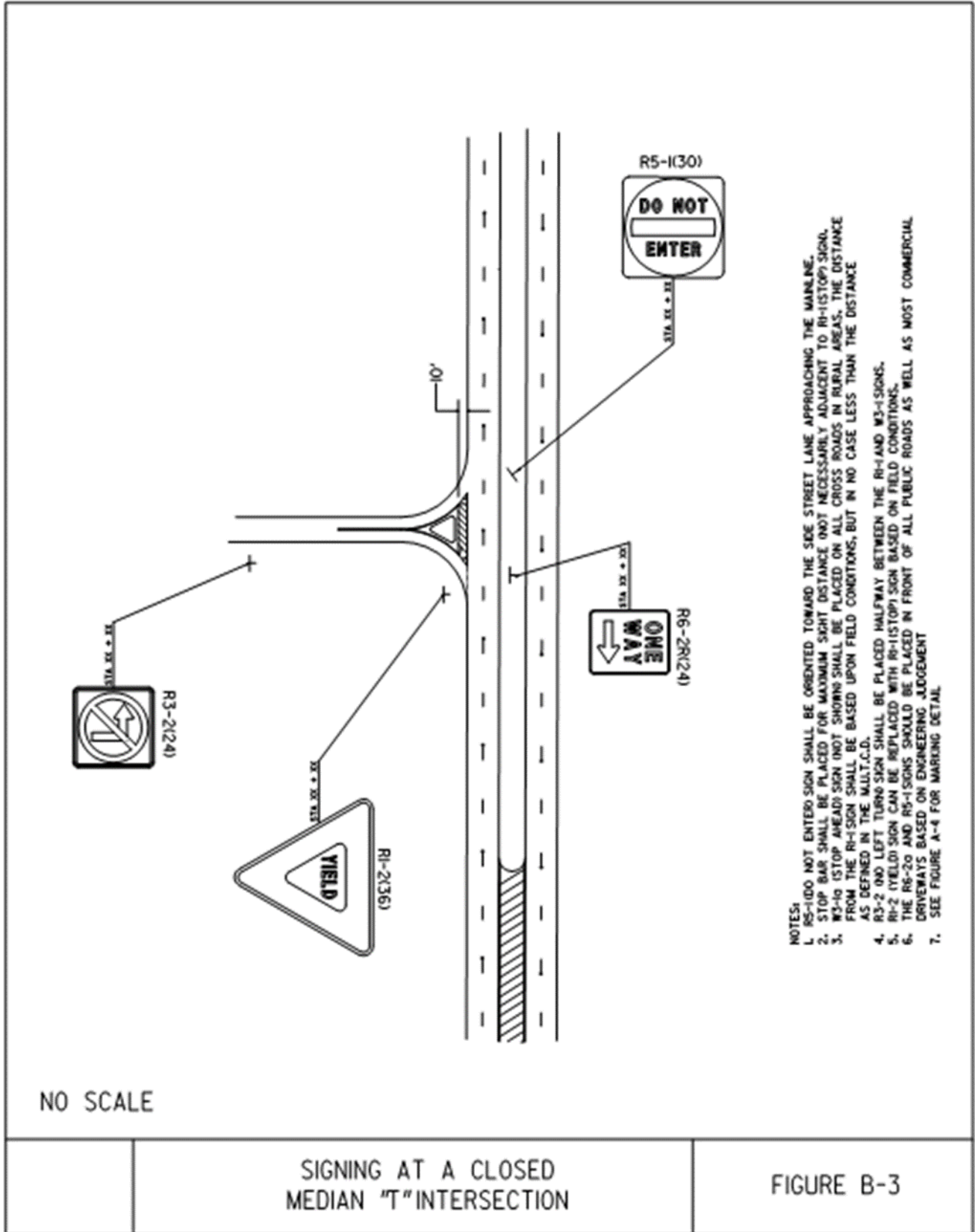

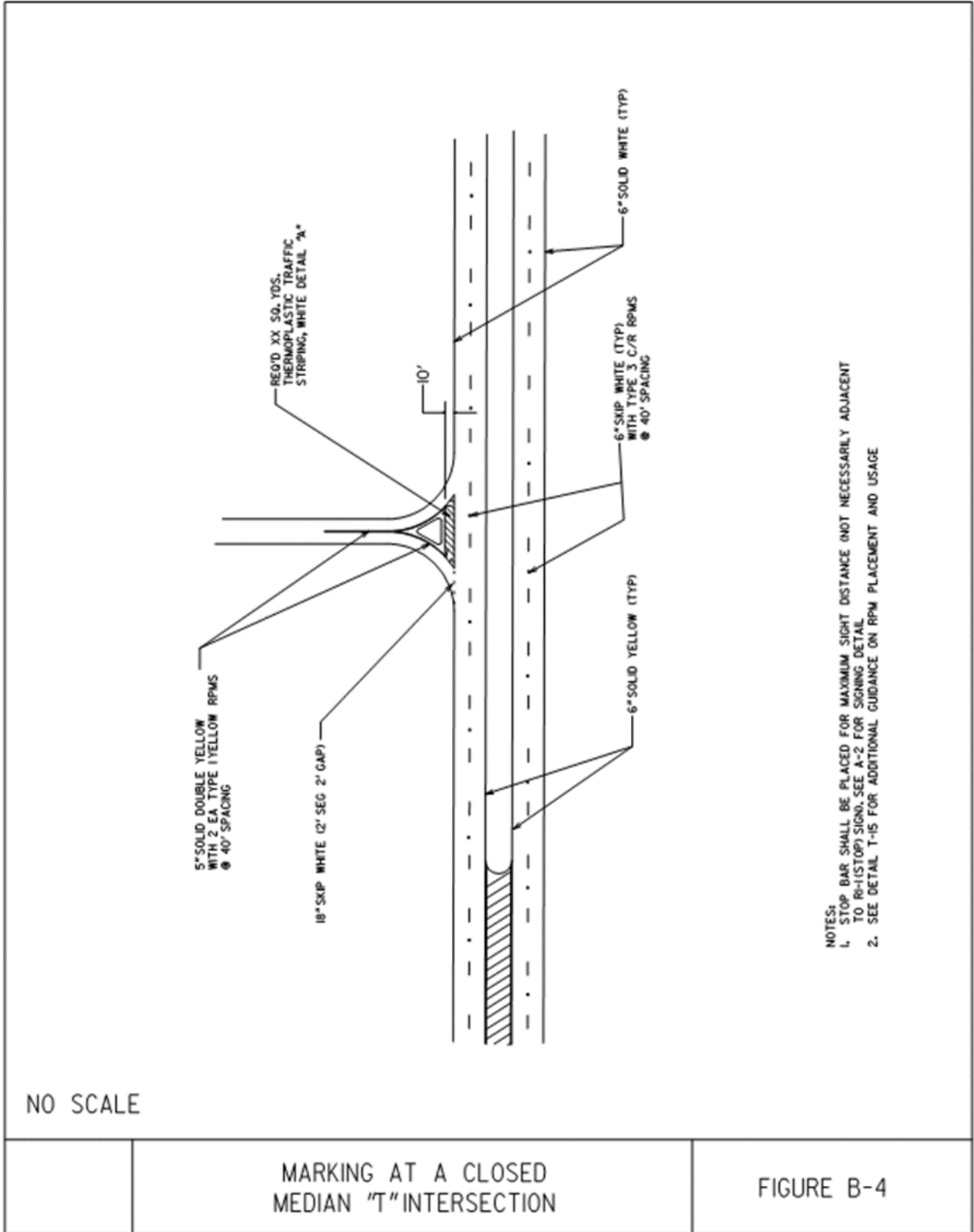

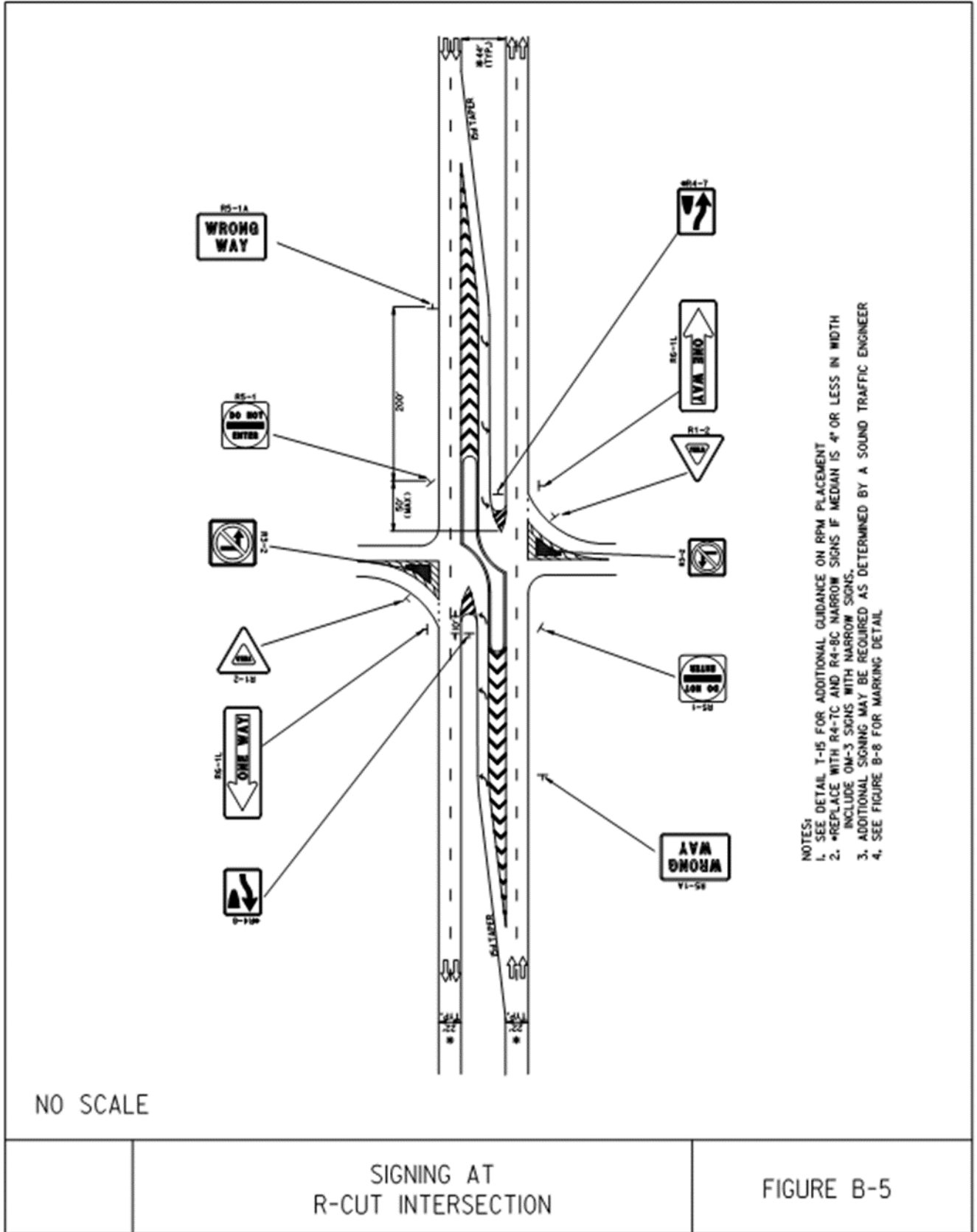

- NOTES:
1. SEE DETAIL T-15 FOR ADDITIONAL GUIDANCE ON RPM PLACEMENT
 2. *REPLACE WITH R4-7C AND R4-8C NARROW SIGNS IF MEDIAN IS 4' OR LESS IN WIDTH
 3. INCLUDE OM-3 SIGNS WITH NARROW SIGNS.
 4. ADDITIONAL SIGNING MAY BE REQUIRED AS DETERMINED BY A SOUND TRAFFIC ENGINEER

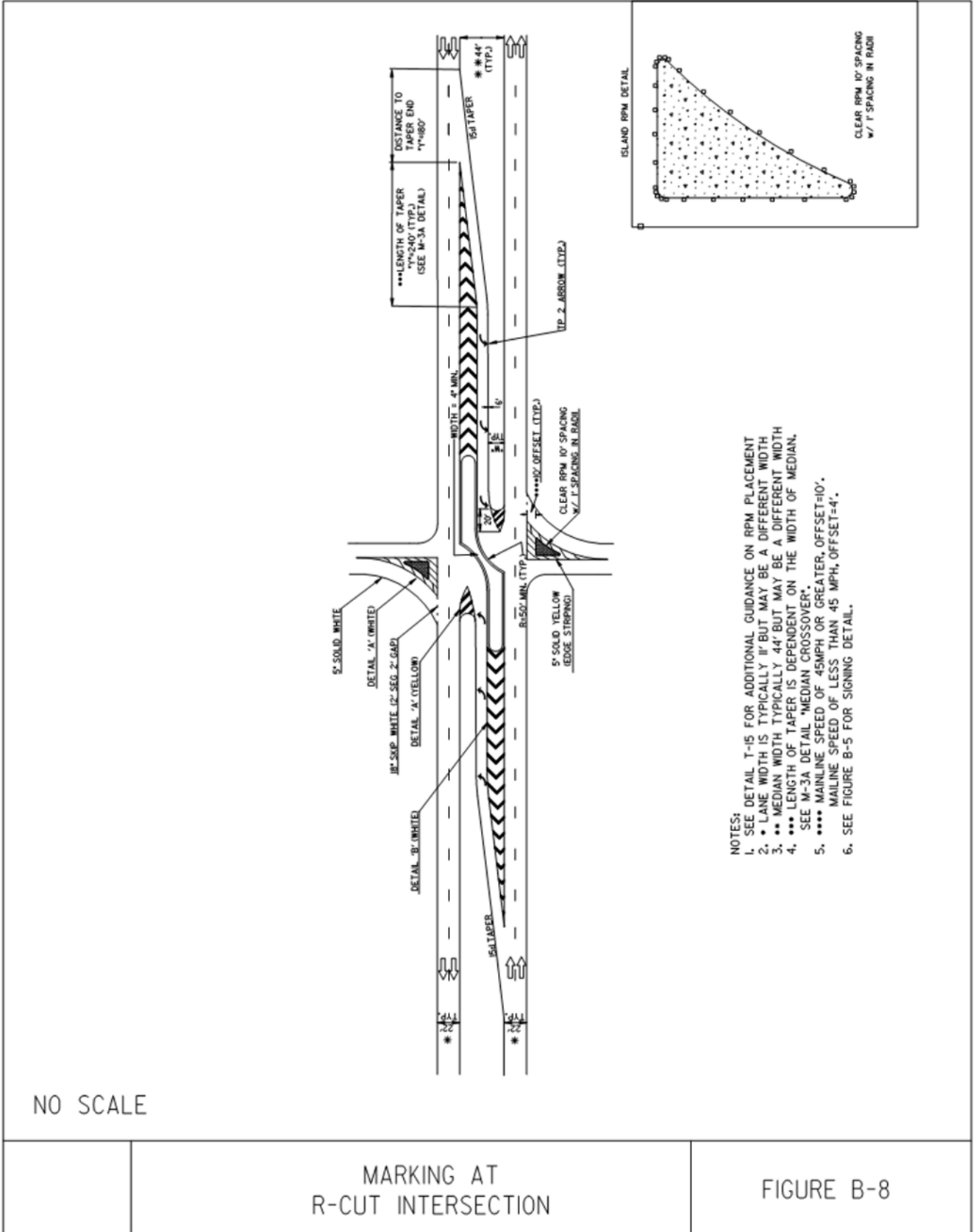

- NOTES:
1. SEE DETAIL T-15 FOR ADDITIONAL GUIDANCE ON RPM PLACEMENT
 2. * LANE WIDTH IS TYPICALLY 11' BUT MAY BE A DIFFERENT WIDTH
 3. ** MEDIAN WIDTH TYPICALLY 44' BUT MAY BE A DIFFERENT WIDTH
 4. *** LENGTH OF TAPER IS DEPENDENT ON THE WIDTH OF MEDIAN. SEE M-3A DETAIL "MEDIAN CROSSOVER".
 5. **** MAINLINE SPEED OF 45MPH OR GREATER, OFFSET=10'.
 6. SEE FIGURE B-5 FOR SIGNING DETAIL.

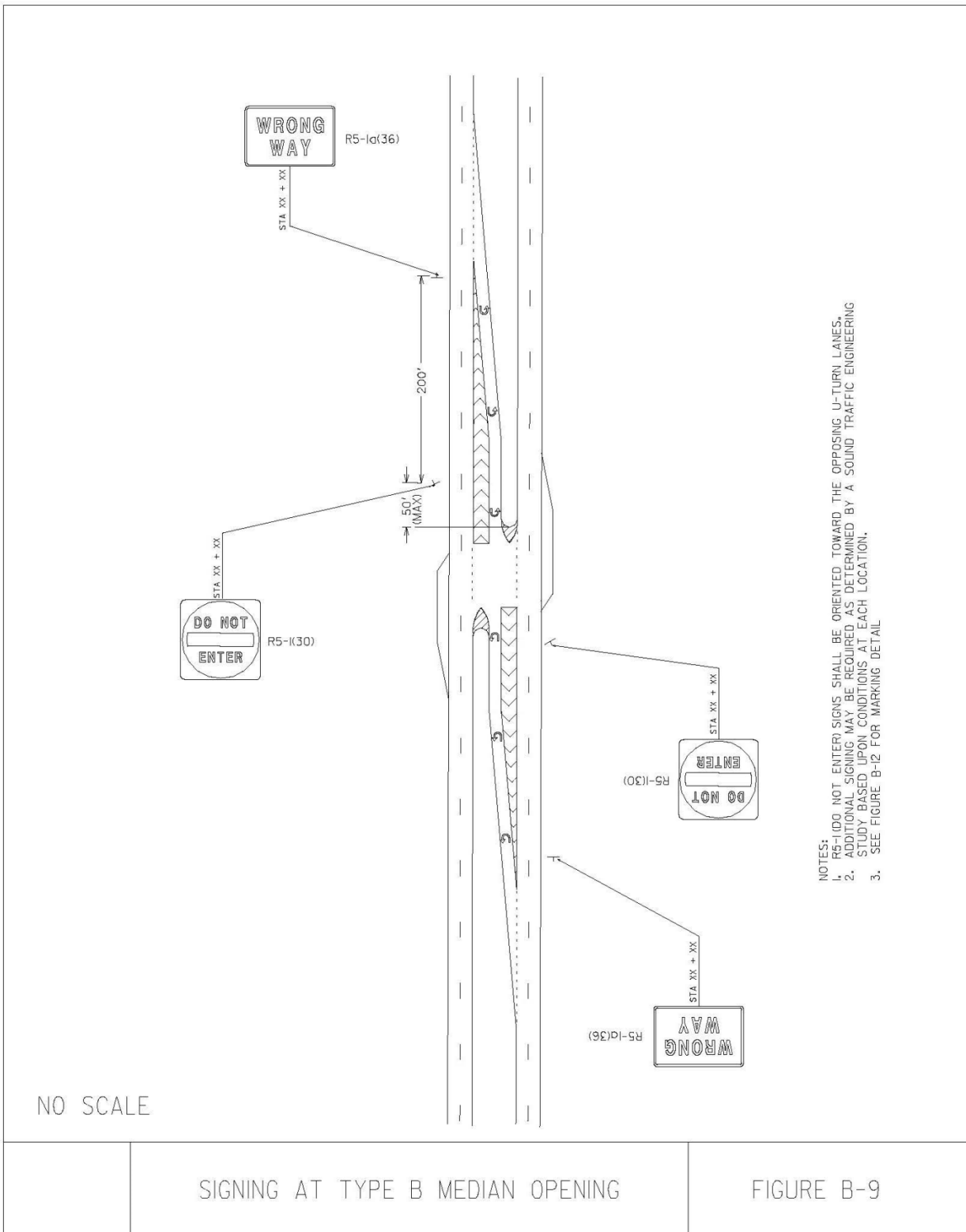

- NOTES:
1. R5-1(30) NOT ENTER SIGNS SHALL BE ORIENTED TOWARD THE OPPOSING U-TURN LANES.
 2. ADDITIONAL SIGNING MAY BE REQUIRED AS DETERMINED BY A SOUND TRAFFIC ENGINEERING STUDY BASED UPON CONDITIONS AT EACH LOCATION.
 3. SEE FIGURE B-12 FOR MARKING DETAIL.

SIGNING AT TYPE B MEDIAN OPENING

FIGURE B-9

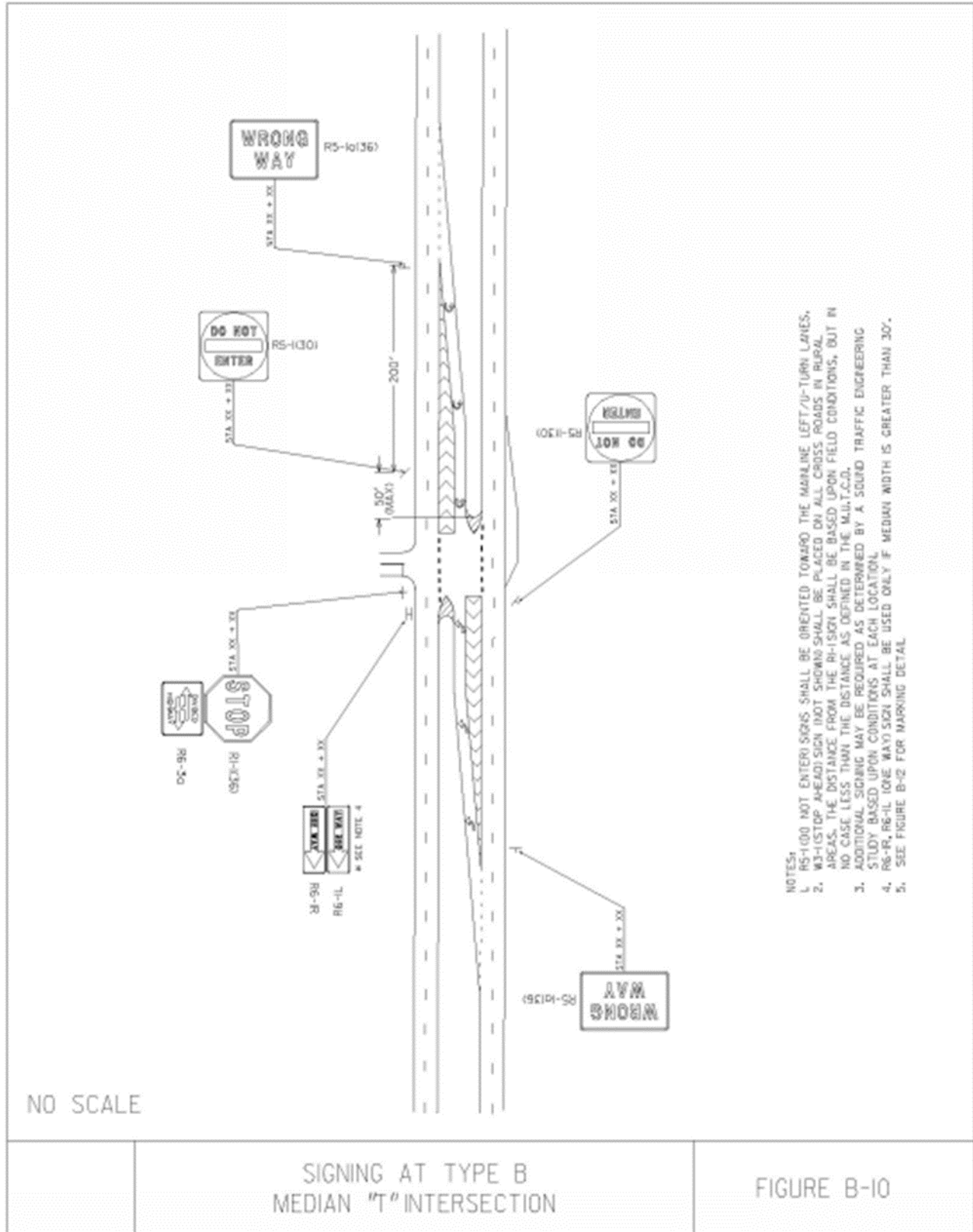

- NOTES:
1. RS-1000 NOT ENTER SIGN SHALL BE ORIENTED TOWARD THE MAINLINE LEFT/UP-TURN LANES.
 2. W3-1510P AHEAD SIGN NOT SHOWN SHALL BE PLACED ON ALL CROSS ROADS IN RURAL AREAS. THE DISTANCE FROM THE R1-1501 SHALL BE BASED UPON FIELD CONDITIONS, BUT IN NO CASE LESS THAN THE DISTANCE AS DEFINED IN THE M.U.T.C.D.
 3. ADDITIONAL SIGNING MAY BE REQUIRED AS DETERMINED BY A SCOUR TRAFFIC ENGINEERING STUDY BASED UPON CONDITIONS AT EACH LOCATION.
 4. R6-R, R6-L (ONE WAY) SIGN SHALL BE USED ONLY IF MEDIAN WIDTH IS GREATER THAN 30'.
 5. SEE FIGURE B-2 FOR MARKING DETAIL.

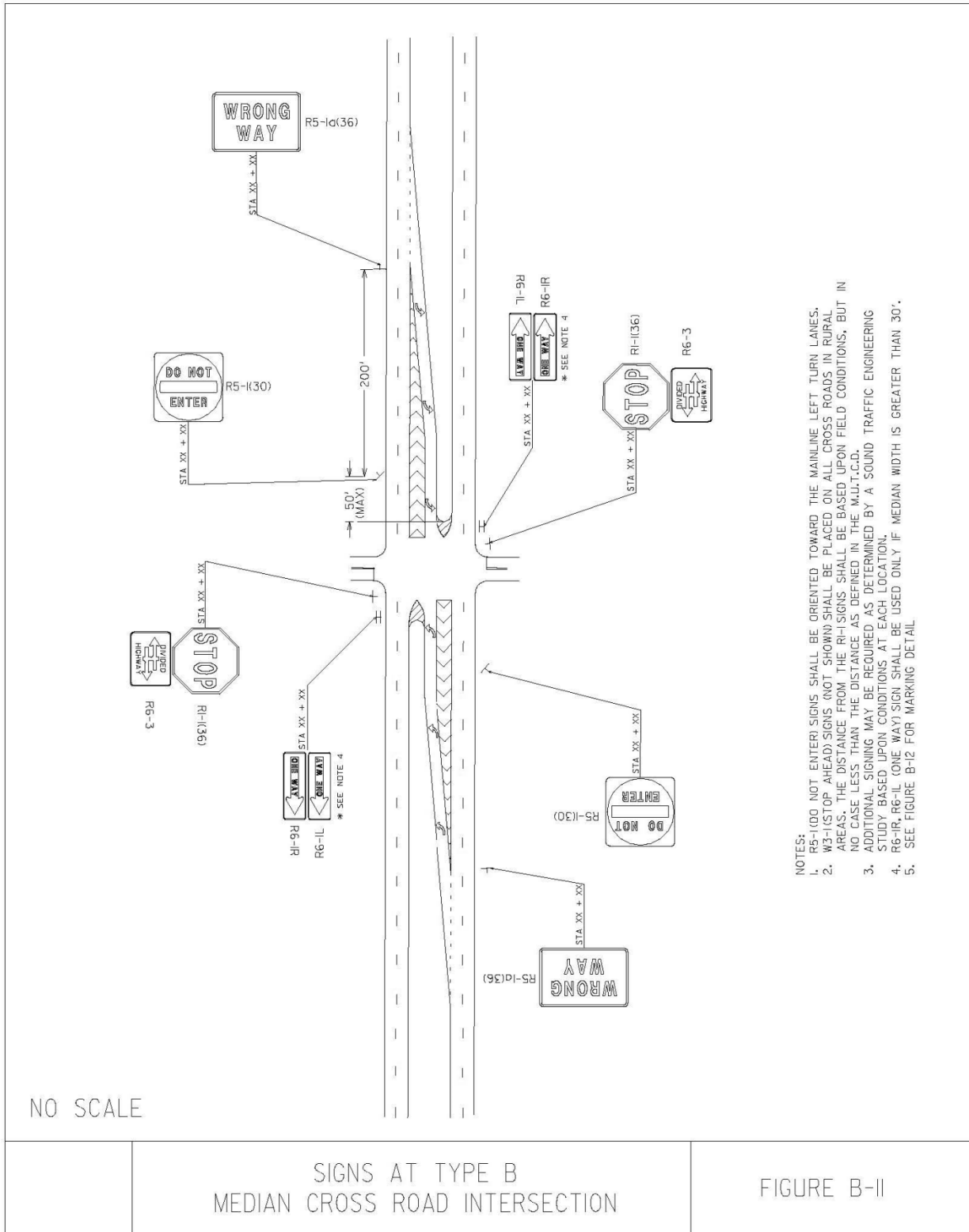

- NOTES:
1. R5-1(DO NOT ENTER) SIGNS SHALL BE ORIENTED TOWARD THE MAINLINE LEFT TURN LANES.
 2. W3-1(STOP-AHEAD) SIGNS (NOT SHOWN) SHALL BE PLACED ON ALL CROSS ROADS IN RURAL AREAS. THE DISTANCE FROM THE R1-1 SIGNS SHALL BE BASED UPON FIELD CONDITIONS, BUT IN NO CASE LESS THAN THE DISTANCE AS DEFINED IN THE M.U.T.C.D.
 3. ADDITIONAL SIGNING MAY BE REQUIRED AS DETERMINED BY A SOUND TRAFFIC ENGINEERING STUDY BASED UPON CONDITIONS AT EACH LOCATION.
 4. R6-1R, R6-1L (ONE WAY) SIGN SHALL BE USED ONLY IF MEDIAN WIDTH IS GREATER THAN 30'.
 5. SEE FIGURE B-12 FOR MARKING DETAIL

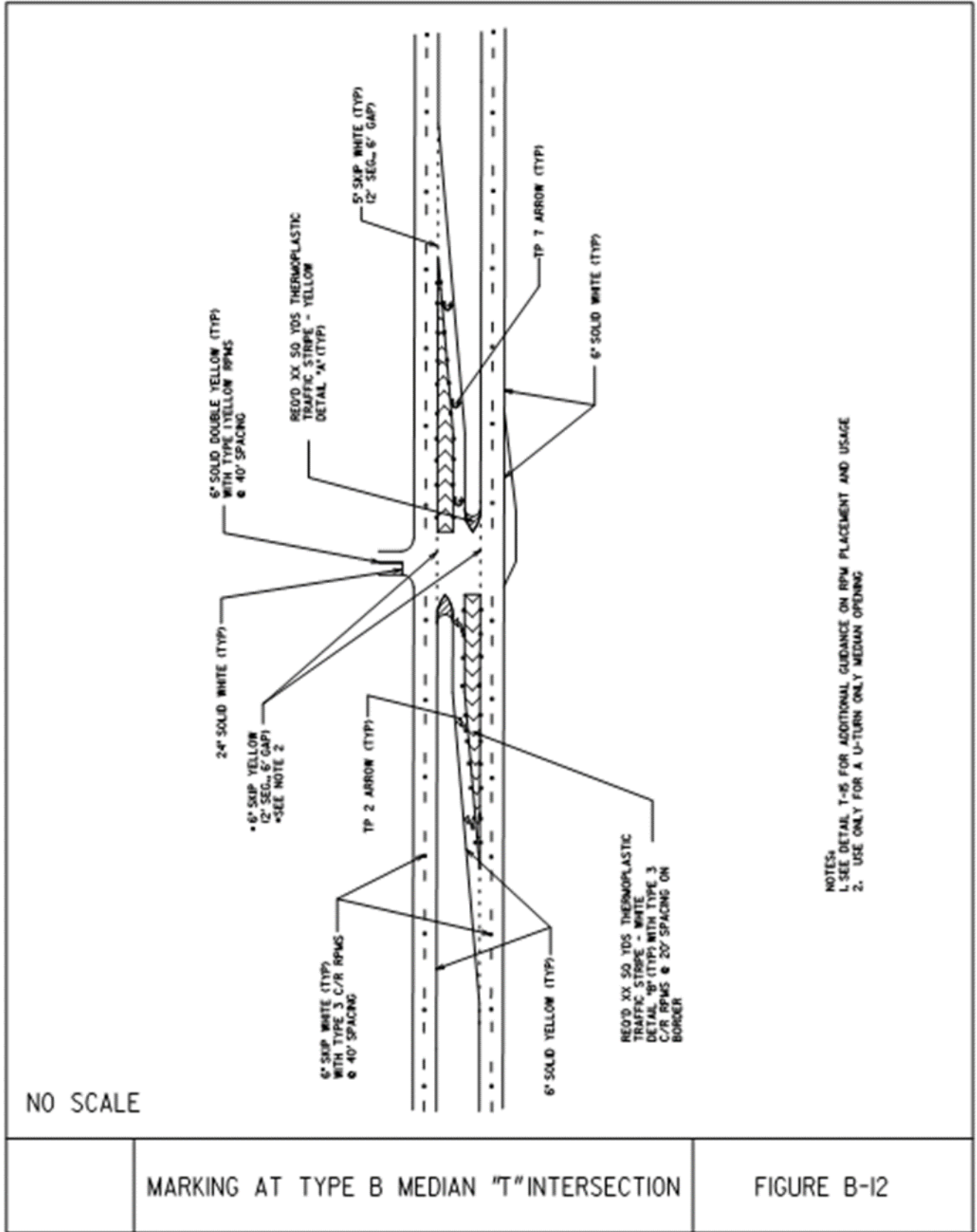

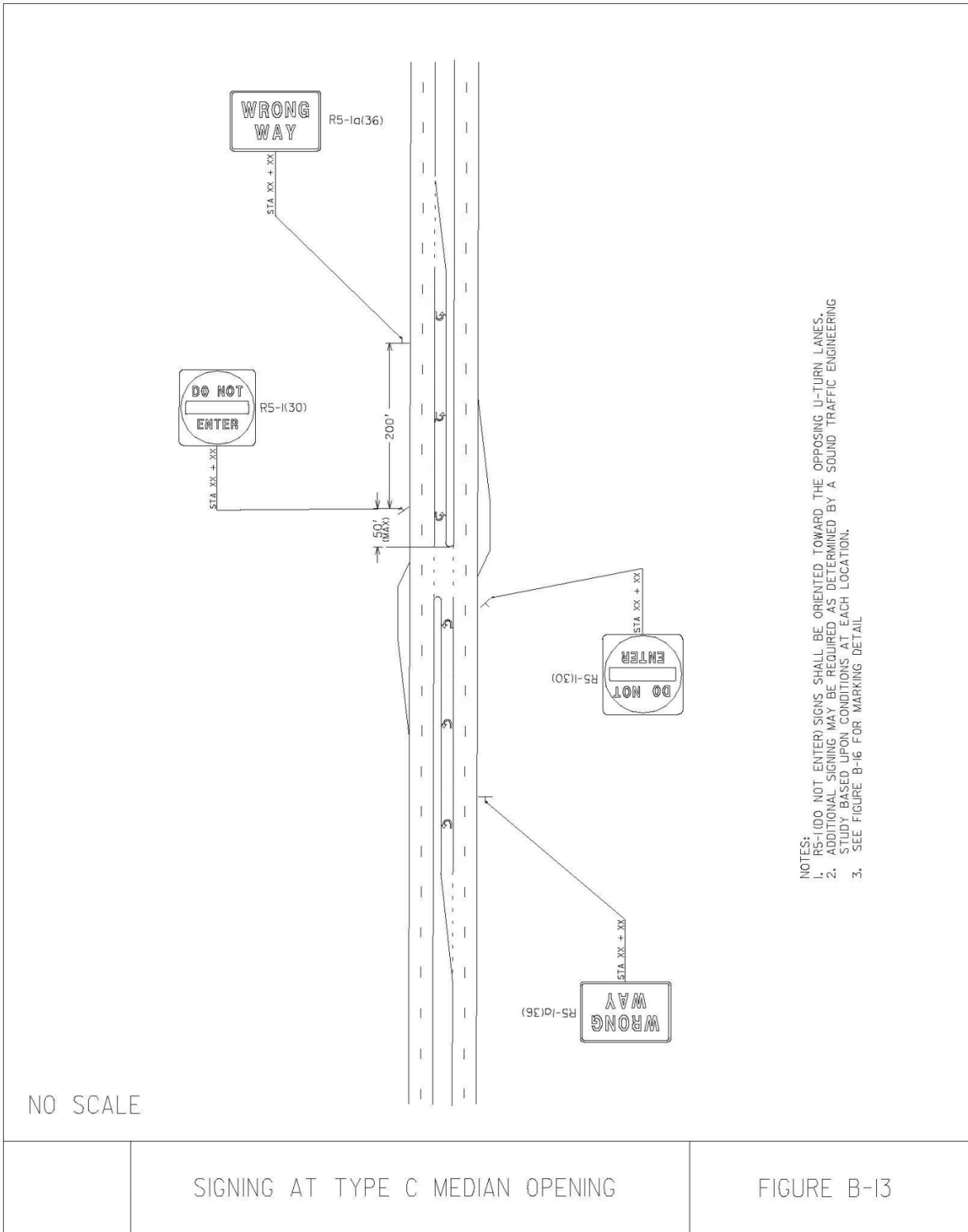

- NOTES:
1. R5-1(DO NOT ENTER) SIGNS SHALL BE ORIENTED TOWARD THE OPPOSING U-TURN LANES.
 2. ADDITIONAL SIGNING MAY BE REQUIRED AS DETERMINED BY A SOUND TRAFFIC ENGINEERING STUDY BASED UPON CONDITIONS AT EACH LOCATION.
 3. SEE FIGURE B-16 FOR MARKING DETAIL.

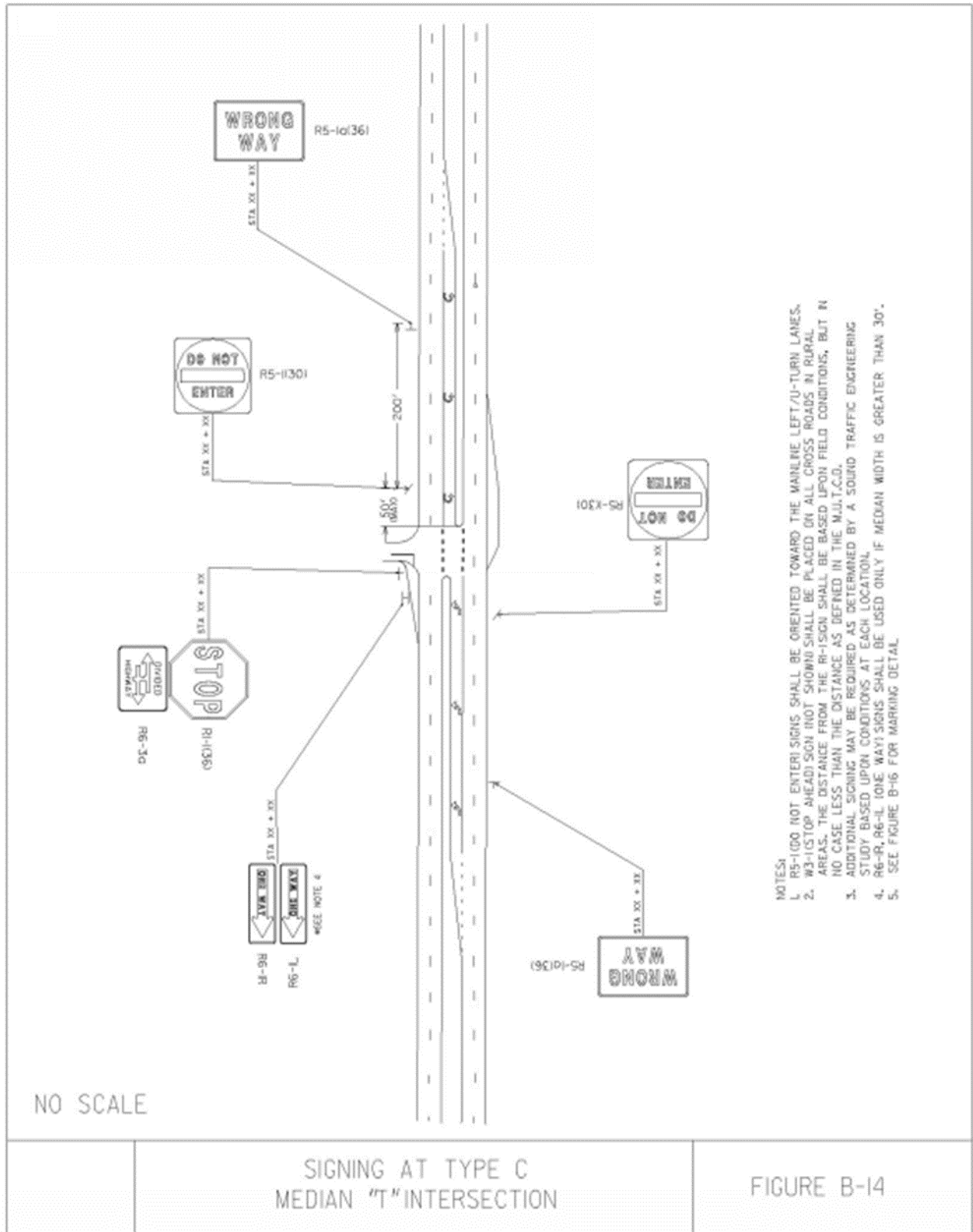

- NOTES:
1. R5-1(00) NOT ENTER SIGN SHALL BE ORIENTED TOWARD THE MAINLINE LEFT-TURN LANES.
 2. W3-1(STOP) AHEAD SIGN (NOT SHOWN) SHALL BE PLACED ON ALL CROSS ROADS IN RURAL AREAS. THE DISTANCE FROM THE R5-1 SIGN SHALL BE BASED UPON FIELD CONDITIONS, BUT IN NO CASE LESS THAN THE DISTANCE AS DEFINED IN THE M.J.T.C.D.
 3. ADDITIONAL SIGNING MAY BE REQUIRED AS DETERMINED BY A SOUND TRAFFIC ENGINEERING STUDY BASED UPON CONDITIONS AT EACH LOCATION.
 4. R6-R, R6-L (ONE WAY) SIGNS SHALL BE USED ONLY IF MEDIAN WIDTH IS GREATER THAN 30'.
 5. SEE FIGURE B-16 FOR MARKING DETAIL.

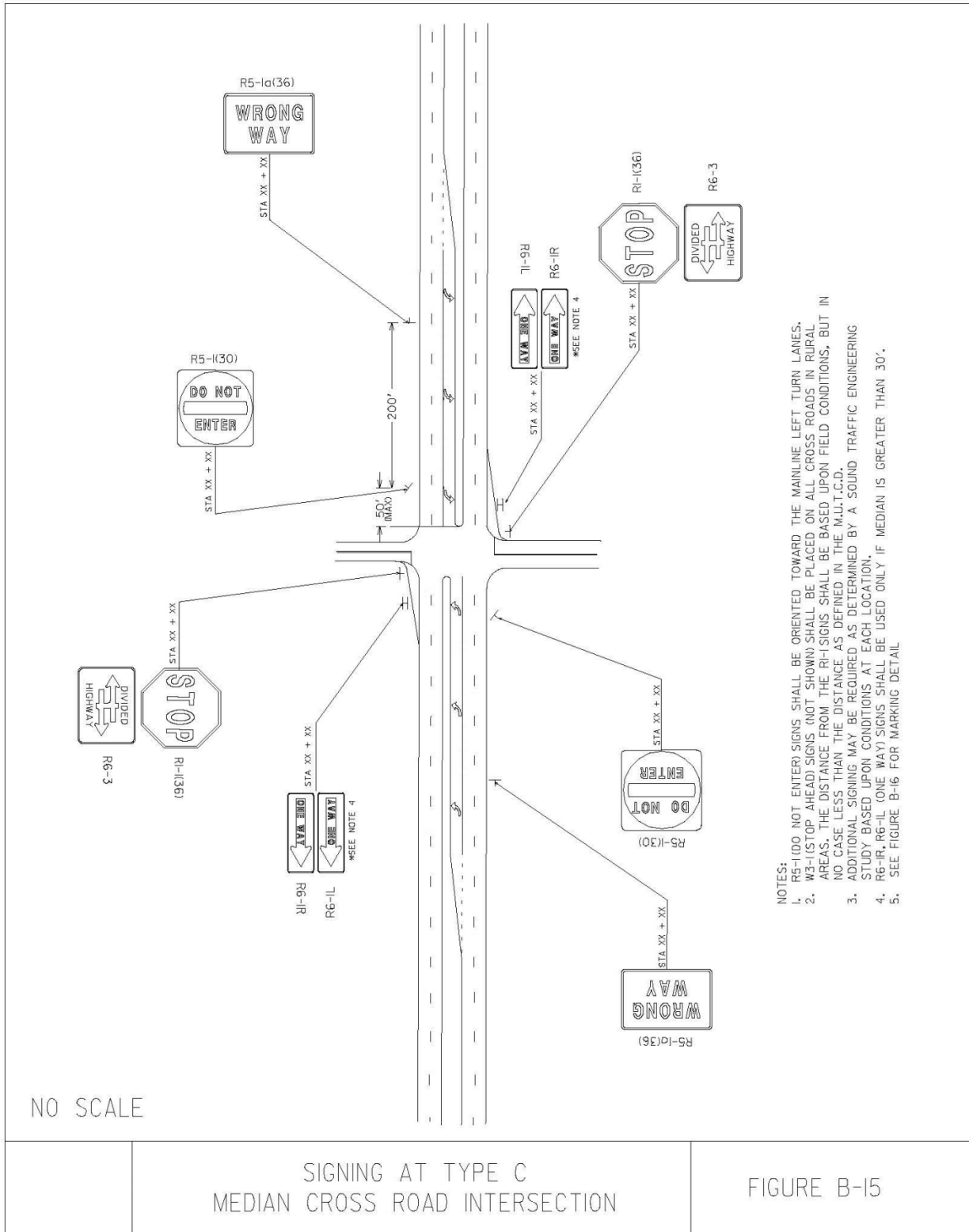

- NOTES:
1. R5-I(DO NOT ENTER) SIGNS SHALL BE ORIENTED TOWARD THE MAINLINE LEFT TURN LANES.
 2. W3-I(STOP AHEAD) SIGNS (NOT SHOWN) SHALL BE PLACED ON ALL CROSS ROADS IN RURAL AREAS. THE DISTANCE FROM THE R-I SIGNS SHALL BE BASED UPON FIELD CONDITIONS, BUT IN NO CASE LESS THAN THE DISTANCE AS DEFINED IN THE M.U.T.C.D.
 3. ADDITIONAL SIGNING MAY BE REQUIRED AS DETERMINED BY A SOUND TRAFFIC ENGINEERING STUDY BASED UPON CONDITIONS AT EACH LOCATION.
 4. R6-1R, R6-1L (ONE WAY) SIGNS SHALL BE USED ONLY IF MEDIAN IS GREATER THAN 30'.
 5. SEE FIGURE B-16 FOR MARKING DETAIL

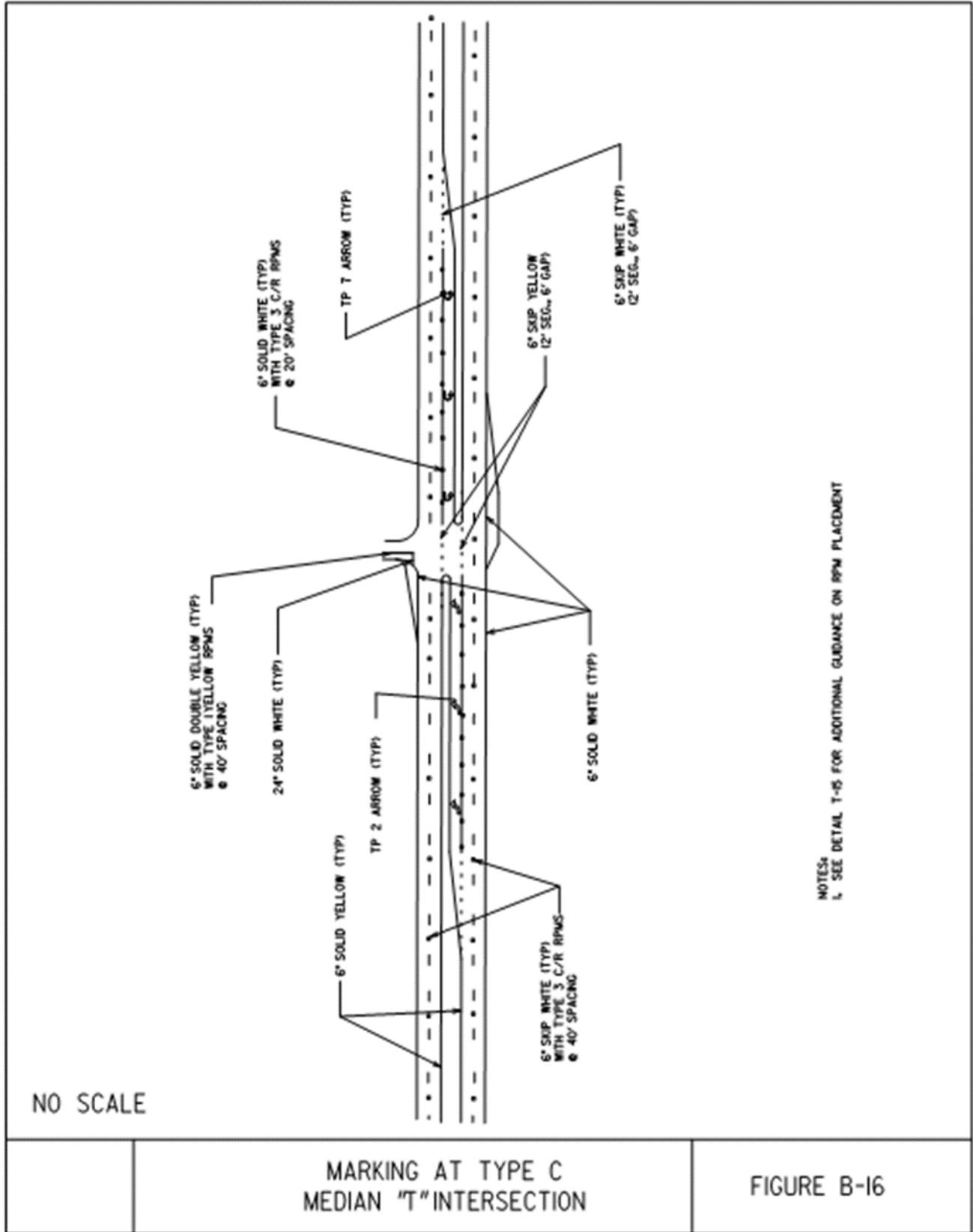

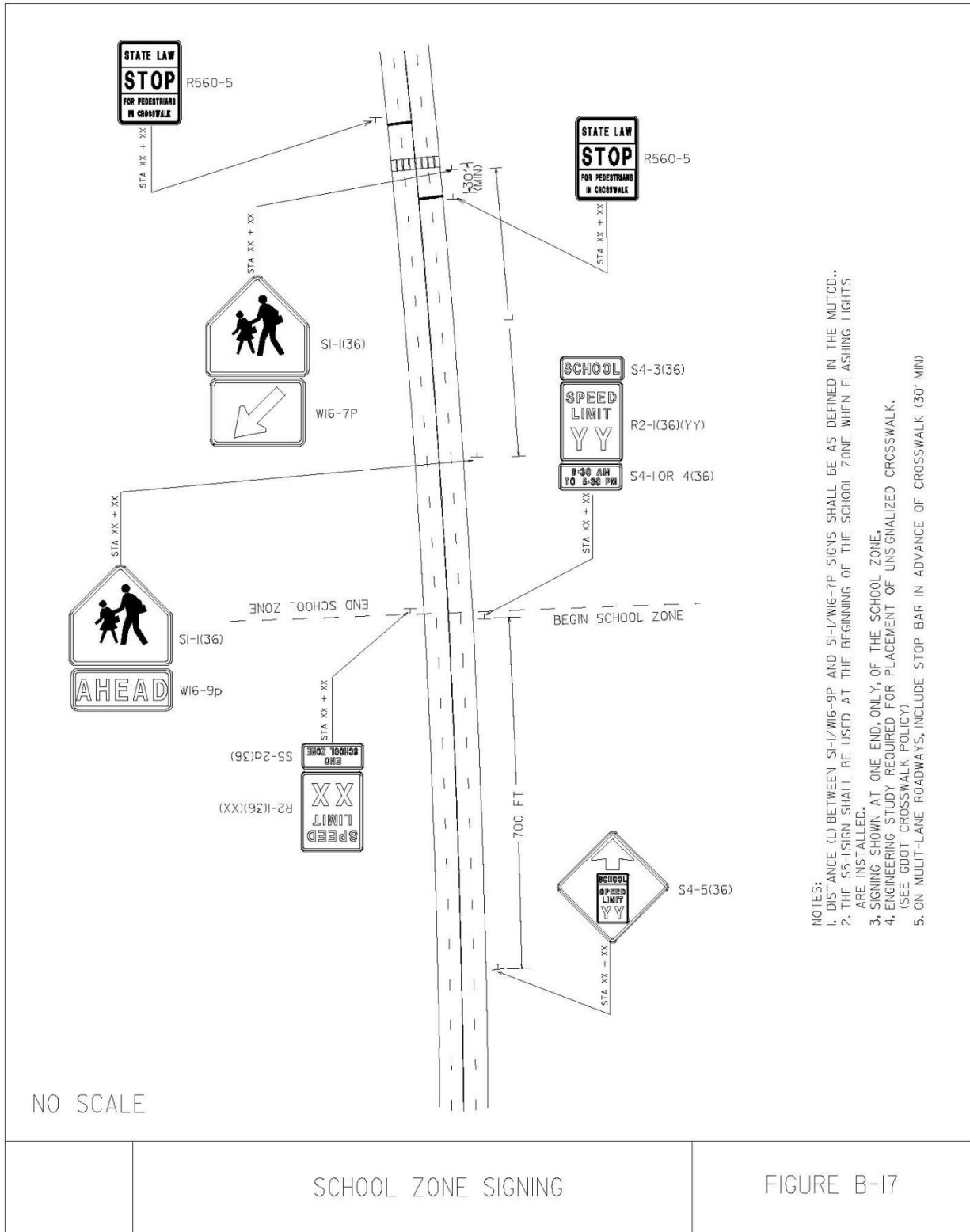

- NOTES:
1. DISTANCE (L) BETWEEN SI-1/W16-9P AND SI-1/W16-7P SIGNS SHALL BE AS DEFINED IN THE MUTCD.
 2. THE S5-1 SIGN SHALL BE USED AT THE BEGINNING OF THE SCHOOL ZONE WHEN FLASHING LIGHTS ARE INSTALLED.
 3. SIGNING SHOWN AT ONE END ONLY OF THE SCHOOL ZONE.
 4. ENGINEERING STUDY REQUIRED FOR PLACEMENT OF UNSIGNALIZED CROSSWALK. (SEE GDOT CROSSWALK POLICY)
 5. ON MULTI-LANE ROADWAYS, INCLUDE STOP BAR IN ADVANCE OF CROSSWALK (30' MIN)

SCHOOL ZONE SIGNING

FIGURE B-17

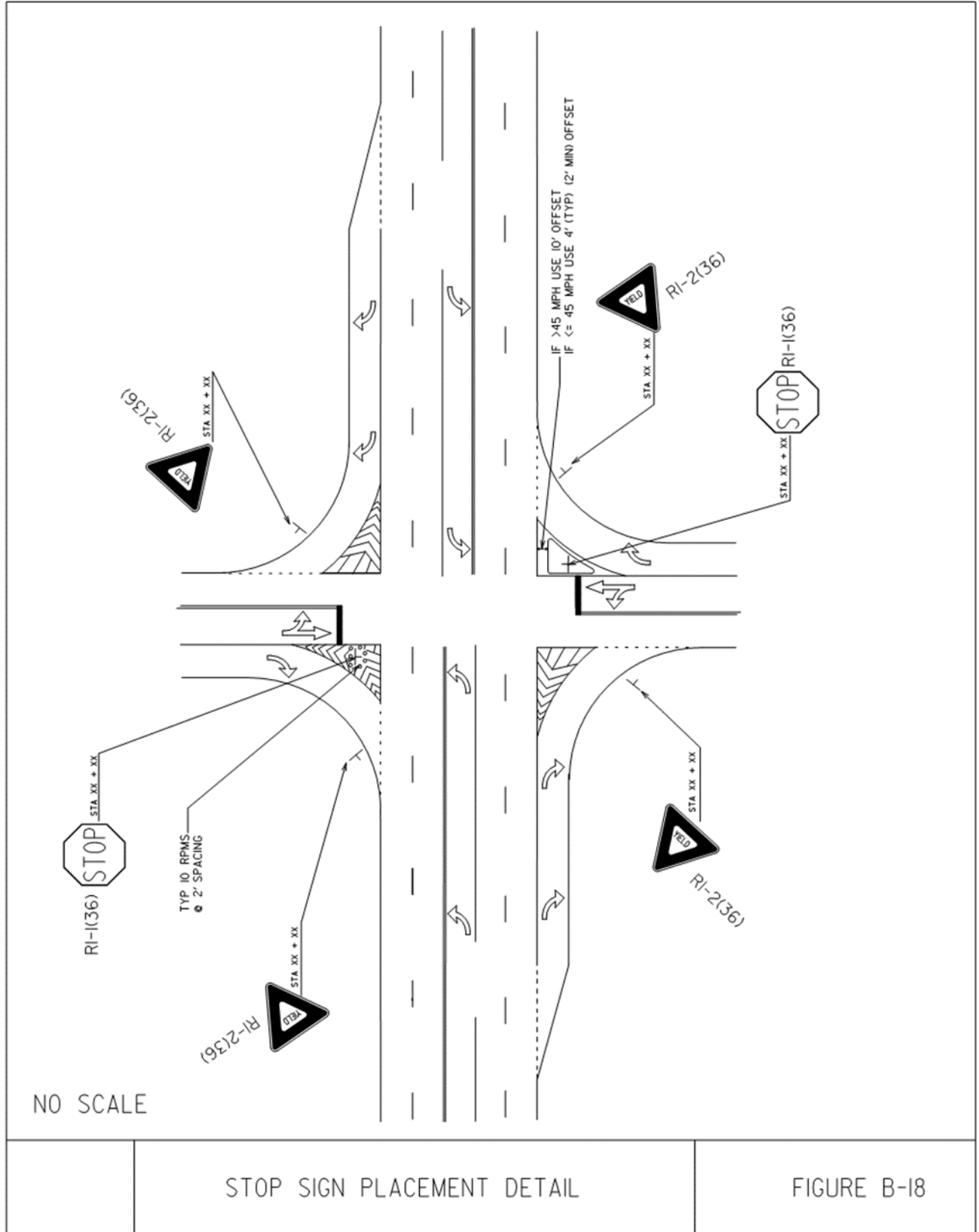

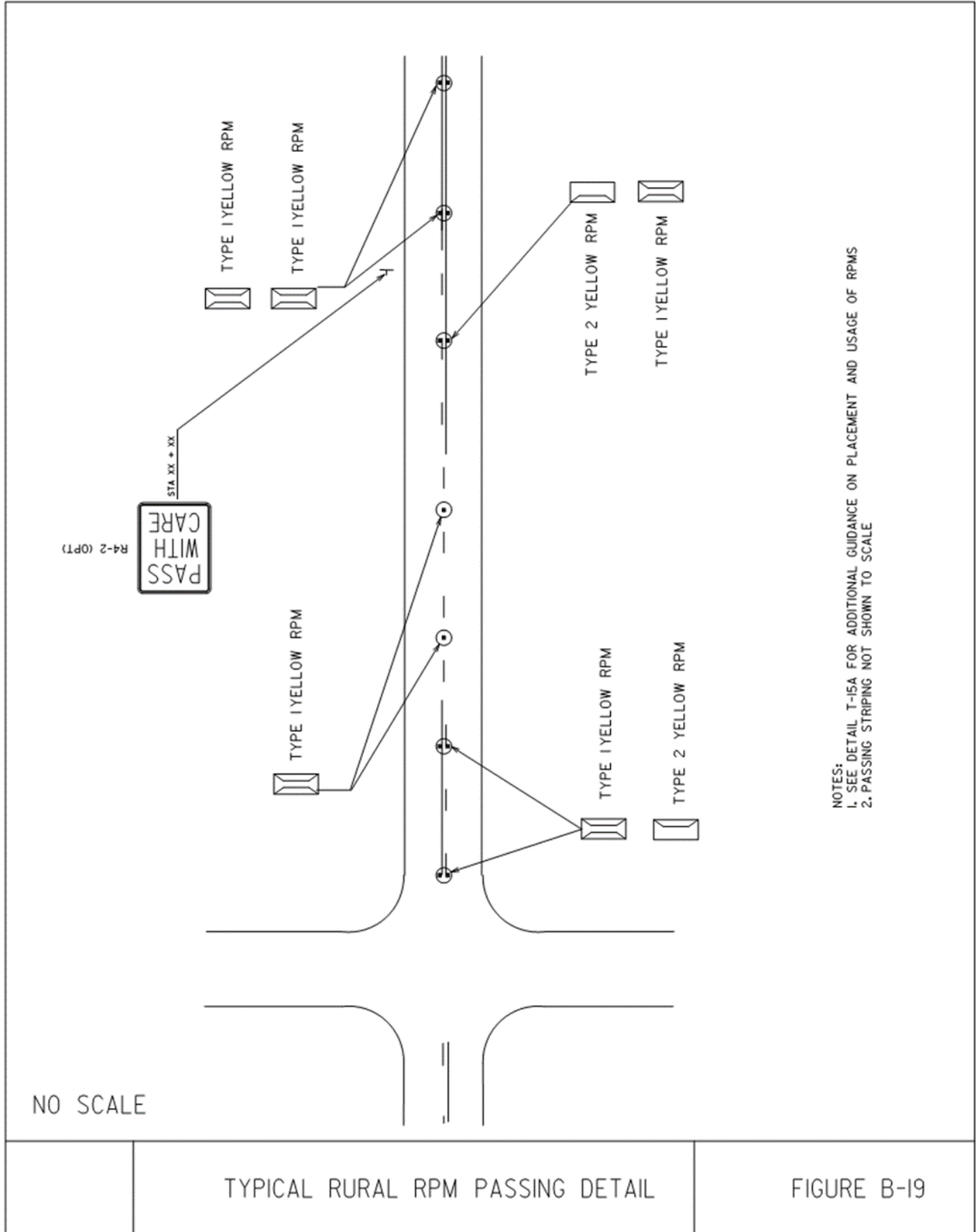

NOTES:
 1. SEE DETAIL T-15A FOR ADDITIONAL GUIDANCE ON PLACEMENT AND USAGE OF RPMs
 2. PASSING STRIPING NOT SHOWN TO SCALE

	TYPICAL RURAL RPM PASSING DETAIL	FIGURE B-19
--	----------------------------------	-------------

Appendix C. Bicycle Signing and Marking

- C-1 Bicycle Lane Signing and Marking (four-lane divided highway)
- C-2 Bicycle Shoulder Signing and Marking
- C-3 Bicycle Lane Signing and Marking (two-lane highway)

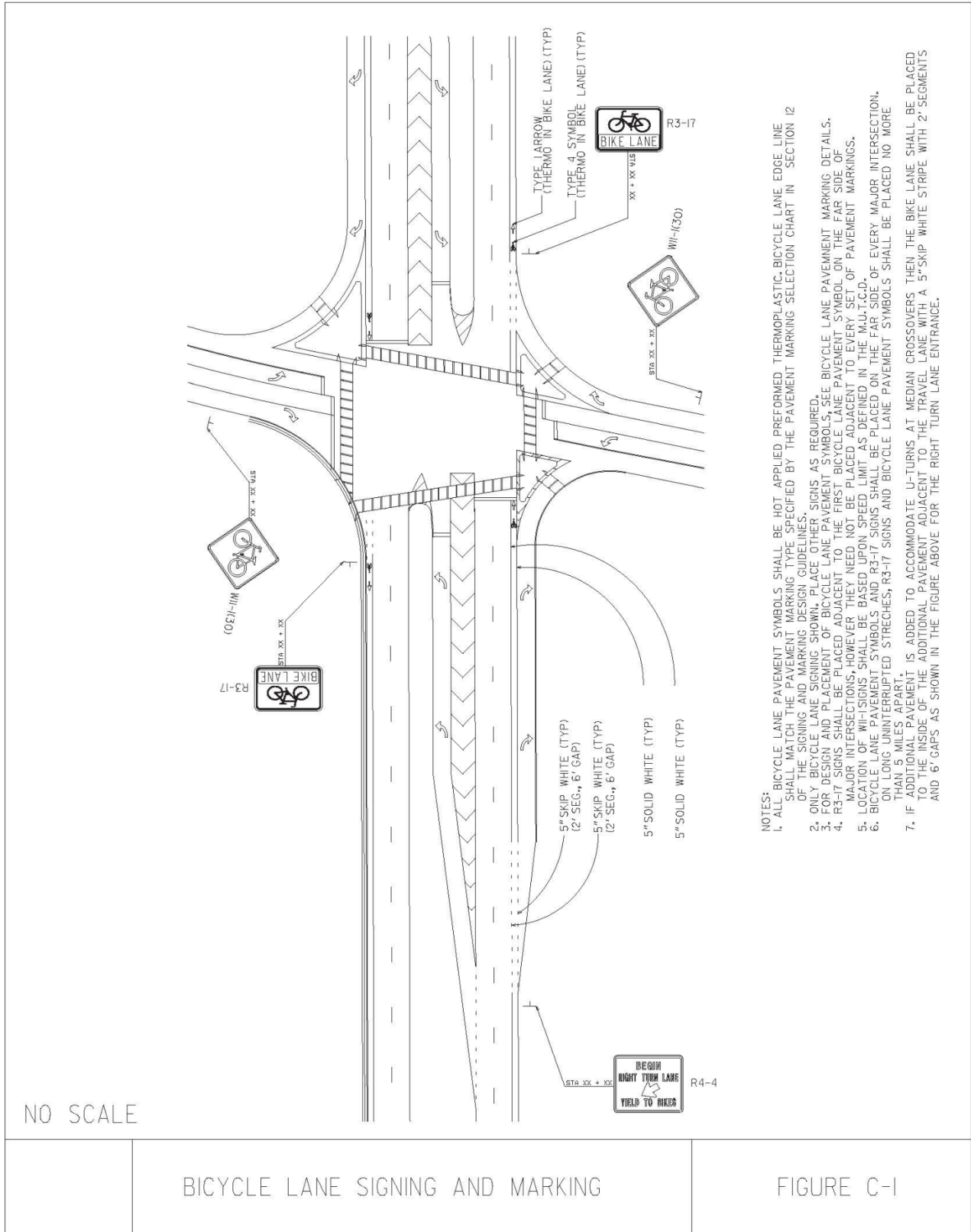

- NOTES:
1. ALL BICYCLE LANE PAVEMENT SYMBOLS SHALL BE HOT APPLIED PREFORMED THERMOPLASTIC BICYCLE LANE EDGE LINE SHALL MATCH THE PAVEMENT MARKING TYPE SPECIFIED BY THE PAVEMENT MARKING SELECTION CHART IN SECTION 12 OF THE SIGNING AND MARKING DESIGN GUIDELINES.
 2. ONLY BICYCLE LANE SIGNING SHOULD BE PLACED ON OTHER SIGNS AS REQUIRED.
 3. FOR DESIGN AND PLACEMENT OF BICYCLE LANE PAVEMENT SYMBOLS, SEE BICYCLE LANE PAVEMENT MARKING DETAILS.
 4. R3-17 SIGNS SHALL BE PLACED ADJACENT TO THE FIRST BICYCLE LANE PAVEMENT SYMBOL ON THE FAR SIDE OF MAJOR INTERSECTIONS, HOWEVER THEY NEED NOT BE PLACED ADJACENT TO EVERY SET OF PAVEMENT MARKINGS.
 5. LOCATION OF W1-1(30) SIGNS SHALL BE BASED UPON SPEED LIMIT AS DEFINED IN THE MUTCD.
 6. BICYCLE LANE PAVEMENT SYMBOLS AND R3-17 SIGNS SHALL BE PLACED ON THE FAR SIDE OF EVERY MAJOR INTERSECTION, ON LONG UNINTERRUPTED STRETCHES, R3-17 SIGNS AND BICYCLE LANE PAVEMENT SYMBOLS SHALL BE PLACED NO MORE THAN 5 MILES APART.
 7. IF ADDITIONAL PAVEMENT IS ADDED TO ACCOMMODATE U-TURNS AT MEDIAN CROSSOVERS THEN THE BICYCLE LANE SHALL BE PLACED TO THE INSIDE OF THE ADDITIONAL PAVEMENT ADJACENT TO THE TRAVEL LANE WITH A 5" SKIP WHITE STRIPE WITH 2' SEGMENTS AND 6' GAPS AS SHOWN IN THE FIGURE ABOVE FOR THE RIGHT TURN LANE ENTRANCE.

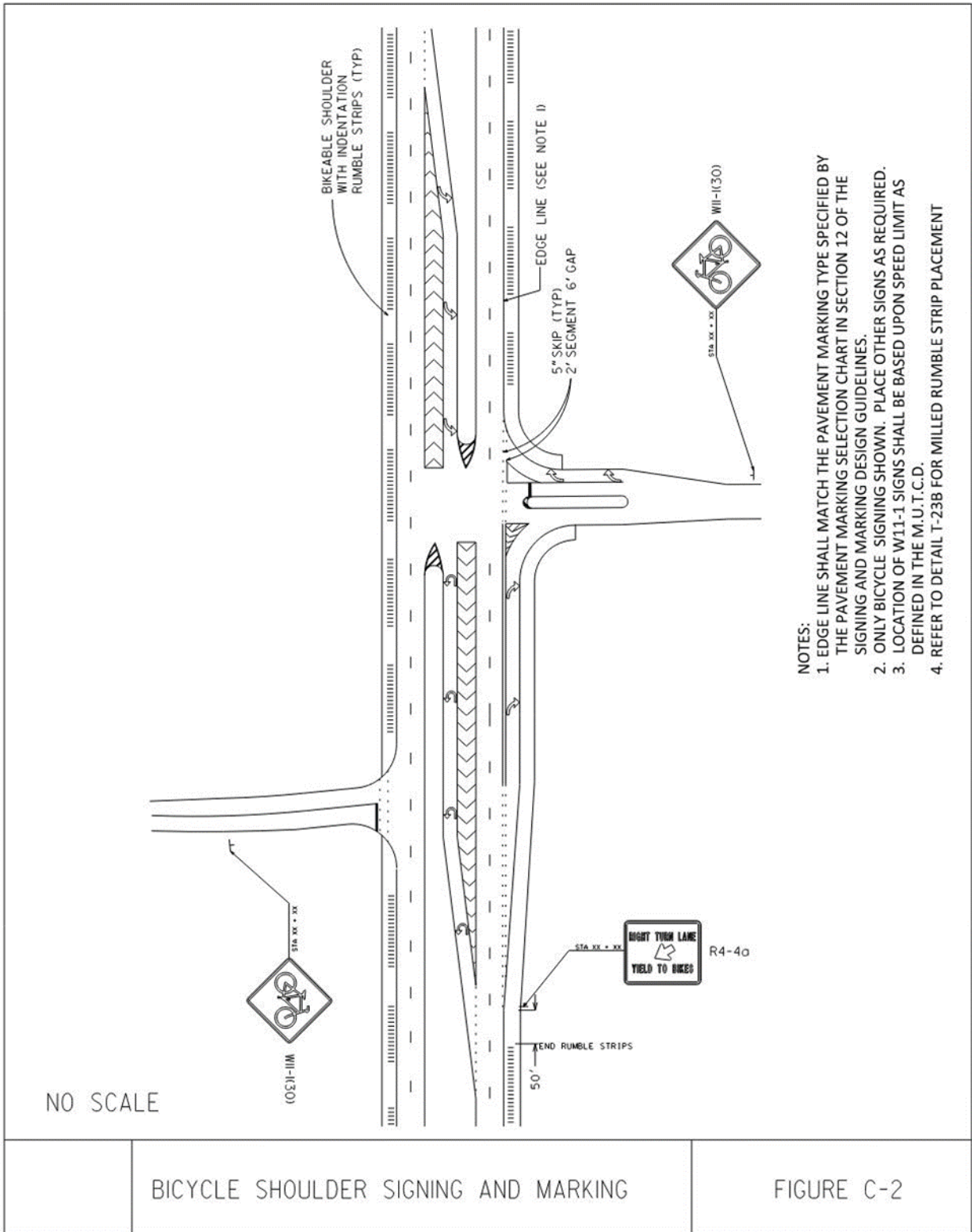

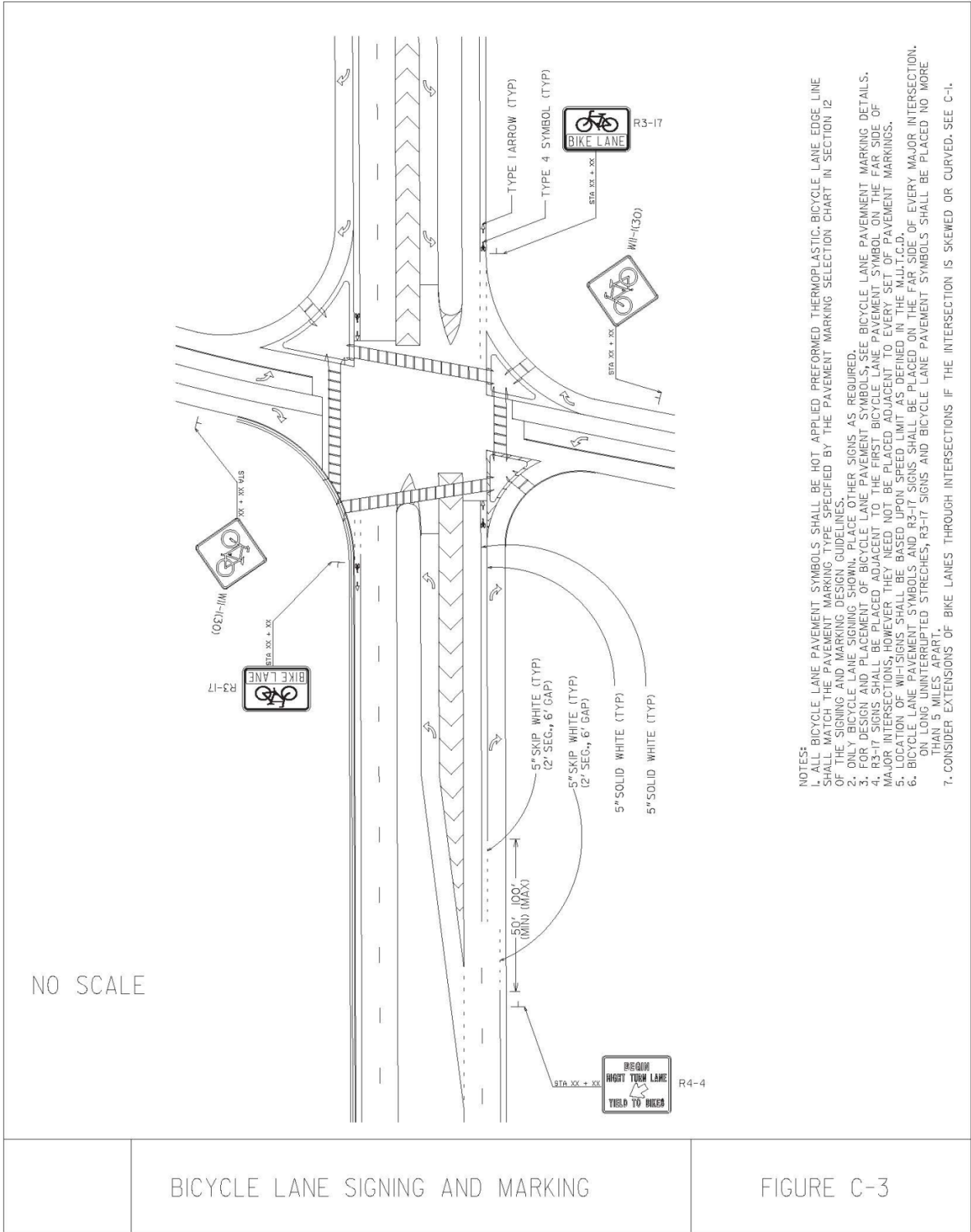

- NOTES:
1. ALL BICYCLE LANE PAVEMENT SYMBOLS SHALL BE HOT APPLIED PREFORMED THERMOPLASTIC. BICYCLE LANE EDGE LINE SHALL MATCH THE PAVEMENT MARKING TYPE SPECIFIED BY THE PAVEMENT MARKING SELECTION CHART IN SECTION 12 OF THE SIGNING AND MARKING DESIGN GUIDELINES.
 2. ONLY BICYCLE LANE SIGNING SHOWN. PLACE OTHER SIGNS AS REQUIRED.
 3. FOR DESIGN AND PLACEMENT OF BICYCLE LANE PAVEMENT SYMBOLS, SEE BICYCLE LANE PAVEMENT MARKING DETAILS.
 4. R3-17 SIGNS SHALL BE PLACED ADJACENT TO THE FIRST BICYCLE LANE. PAVEMENT SYMBOL ON THE FAR SIDE OF MAJOR INTERSECTIONS, HOWEVER, THEY NEED NOT BE PLACED ADJACENT TO EVERY SET OF PAVEMENT MARKINGS.
 5. LOCATION OF ALL SIGNS SHALL BE BASED ON THE SPEED LIMIT AS DEFINED IN THE MUTCD.
 6. BICYCLE LANE PAVEMENT SYMBOLS AND R3-17 SIGNS SHALL BE PLACED ON THE FAR SIDE OF EVERY MAJOR INTERSECTION. ON LONG UNINTERRUPTED STRETCHES, R3-17 SIGNS AND BICYCLE LANE PAVEMENT SYMBOLS SHALL BE PLACED NO MORE THAN 5 MILES APART.
 7. CONSIDER EXTENSIONS OF BIKE LANES THROUGH INTERSECTIONS IF THE INTERSECTION IS SKEWED OR CURVED. SEE C-1.

BICYCLE LANE SIGNING AND MARKING

FIGURE C-3

Appendix D. Summary of Quantities

- D-1 Summary of Quantities – Pavement Markings
- D-2 Summary of Quantities – Standard Signs
- D-3 Summary of Quantities – Special Roadside Signs
- D-4 Summary of Quantities – Remove and Remount Special Signs
- D-5 Summary of Quantities – Overhead Highway Signs
- D-6 Summary of Quantities – Remove and Remount Overhead Signs
- D-7 Summary of Quantities – Remove and Reset Logo Signs

PROJECT NUMBER SHEET NO. TOTAL SHEETS	COUNTY STATE	<h2 style="margin: 0;">SUMMARY OF QUANTITIES-PAVEMENT MARKINGS</h2>									
<h3>RAISED PAVEMENT MARKERS (EACH)</h3>											
LOCATION	REFLECTIVE-RAISED YELLOW TYPE 1	REFLECTIVE-RAISED CLEAR TYPE 2	REFLECTIVE-RAISED CLEAR/RED TYPE 3	REFLECTIVE-RAISED YELLOW TYPE 4	REFLECTIVE-RAISED CLEAR TYPE 5	REFLECTIVE-RAISED CLEAR/RED TYPE 6	REFLECTIVE-RAISED YELLOW TYPE 7	REFLECTIVE-RAISED CLEAR TYPE 8	REFLECTIVE-RAISED CLEAR/RED TYPE 9	REFLECTIVE-RAISED YELLOW TYPE 10	CHANNEL MARK
STREET NAME 1	---	---	---	---	---	---	---	---	---	---	---
STREET NAME 2	---	---	---	---	---	---	---	---	---	---	---
STREET NAME 3	---	---	---	---	---	---	---	---	---	---	---
STREET NAME 4	---	---	---	---	---	---	---	---	---	---	---
STREET NAME 5	---	---	---	---	---	---	---	---	---	---	---
STREET NAME 6	---	---	---	---	---	---	---	---	---	---	---
TOTALS	---	---	---	---	---	---	---	---	---	---	---
NOTES: 1. TYPE 4, 2, AND 3 PAVEMENT MARKERS SHALL BE SPACED AS SPECIFIED ON THE RAISED PAVEMENT MARKERS LOCATION DETAILS.											
<h3>TRAFFIC STRIPE</h3>											
DESCRIPTION	UNIT	PAINT	THERMOPLASTIC	POLYUREA	PREFORMED						
5" S/SHP WHITE	LN FT	#	#	#	#						
5" S/SHP YELLOW	LN FT	#	#	#	#						
8" S/SHP WHITE	LN FT	#	#	#	#						
8" S/SHP YELLOW	LN FT	#	#	#	#						
10" S/SHP WHITE	LN FT	#	#	#	#						
10" S/SHP YELLOW	LN FT	#	#	#	#						
24" S/SHP WHITE	LN FT	#	#	#	#						
24" S/SHP YELLOW	LN FT	#	#	#	#						
5' S/SHP WHITE	LN MILE	#	#	#	#						
5' S/SHP YELLOW	LN MILE	#	#	#	#						
5' S/SHP CONTRAST	LN FT	#	#	#	#						
8' S/SHP CONTRAST	LN FT	#	#	#	#						
5' S/SHP WHITE	LN MILE	#	#	#	#						
5' S/SHP YELLOW	LN MILE	#	#	#	#						
8' S/SHP CONTRAST	LN MILE	#	#	#	#						
NOTE: PREFORMED 10" S/SHP CONTRAST WILL BE 5" S/SHP WHITE STRIPE BETWEEN TWO 1/2" BLACK STRIPES											
<h3>REM TRAFFIC MARKINGS</h3>											
DESCRIPTION	UNIT	PAINT	THERMOPLASTIC	POLYUREA	PREFORMED						
ARROWS	EA	---	---	---	---						
MATCHING	SY	---	---	---	---						
<h3>ARROWS (EACH)</h3>											
DESCRIPTION	QUANTITY	PAINT	THERMOPLASTIC								
TYPE 1	#	#	#								
TYPE 2	#	#	#								
TYPE 3	#	#	#								
TYPE 4	#	#	#								
TYPE 5	#	#	#								
TYPE 6	#	#	#								
TYPE 7	#	#	#								
<h3>SYMBOLS (EACH)</h3>											
DESCRIPTION	QUANTITY	PAINT	THERMOPLASTIC								
STREET NAME 1	#	#	#								
STREET NAME 2	#	#	#								
STREET NAME 3	#	#	#								
STREET NAME 4	#	#	#								
STREET NAME 5	#	#	#								
STREET NAME 6	#	#	#								
STREET NAME 7	#	#	#								
<h3>WORDS (EACH)</h3>											
DESCRIPTION	QUANTITY	PAINT	THERMOPLASTIC								
TYPE 1	#	#	#								
TYPE 2	#	#	#								
TYPE 3A	#	#	#								
TYPE 3B	#	#	#								
TYPE 4	#	#	#								
TYPE 5	#	#	#								
TYPE 6	#	#	#								
<h3>STRIPE PAINTING (SQ YD)</h3>											
DESCRIPTION	QUANTITY	WHITE	YELLOW								
STRIPE PAINTING (SQ YD)	#	#	#								
<h3>THERMO TRAF STRIPE (SQ YD)</h3>											
DESCRIPTION	QUANTITY	WHITE	YELLOW								
THERMO TRAF STRIPE (SQ YD)	#	#	#								
<h3>PAVEMENT ARROW W/RAISED REFLECTORS (EACH)</h3>											
LOCATION	QUANTITY	PAINT	THERMOPLASTIC								
STREET NAME 1	#	#	#								
STREET NAME 2	#	#	#								
STREET NAME 3	#	#	#								
TOTAL	#	#	#								

STATION	INSTL. NO.	SIGN CODE	SIGN TYPE 1			SIGN TYPE 2			SIGN TYPE 3			SIGN TYPE 4			SIGN TYPE 5			SIGN TYPE 6			SIGN TYPE 7			SIGN TYPE 8			SIGN TYPE 9			SIGN TYPE 10			TOTAL LENGTH	TOTAL QUANTITY	TOTAL SUPPORT EACH
			QTY	SIZE	REF. SHEETING	QTY	SIZE	REF. SHEETING	QTY	SIZE	REF. SHEETING	QTY	SIZE	REF. SHEETING	QTY	SIZE	REF. SHEETING	QTY	SIZE	REF. SHEETING	QTY	SIZE	REF. SHEETING	QTY	SIZE	REF. SHEETING	QTY	SIZE	REF. SHEETING	QTY	SIZE	REF. SHEETING			
STANDARD ROADSIDE SIGNS																																			
STREET NAME 1																																			
STREET NAME 2																																			
STREET NAME 3																																			
TOTAL																																			

SUMMARY OF QUANTITIES
STANDARD ROADSIDE SIGNS

STATE OF GEORGIA
DEPARTMENT OF TRANSPORTATION
OFFICE:
SUMMARY OF QUANTITIES
APPENDIX D-2

GEORGIA
DEPARTMENT
OF
TRANSPORTATION

6-

<p>DATE: 10/29/20</p> <p>SCALE: 1/8" = 1'-0"</p> <p>PROJECT NUMBER: 15341</p> <p>SHEET NO.: 6-3</p> <p>TOTAL SHEETS: 6</p>	<h2>SUMMARY OF QUANTITIES</h2>
--	--------------------------------

SPECIAL ROADSIDE SIGNS												
STATION	INSTALL NO.	SIGN NO.	HIGHWAY SIGNS, ALUMINUM PANELS		GALVANIZED STEEL STRUCTURAL SHAPE POSTS			FOOTINGS				
			SIZE	SQUARE FEET	POST LENGTH	POST SIZE	POUNDS	STUB LENGTH	TYPE	'D'	PIPING 12" X HPS3 IN. L.F.T.	CL. *4" CONC. CUL. YDS.
TOTALS												

<p>GEORGIA DEPARTMENT OF TRANSPORTATION</p>	<p>REVISION DATES</p> <table border="1" style="width: 100%; border-collapse: collapse;"> <tr><td> </td><td> </td></tr> <tr><td> </td><td> </td></tr> <tr><td> </td><td> </td></tr> <tr><td> </td><td> </td></tr> </table>									<p>STATE OF GEORGIA DEPARTMENT OF TRANSPORTATION OFFICE: SUMMARY OF QUANTITIES</p> <p>APPENDIX D-3</p>

PROJECT NUMBER		SHEET NO.		TOTAL SHEETS																																																																																																																																					
STATE	COUNTY	PROJECT NUMBER	SHEET NO.	TOTAL SHEETS	DATE																																																																																																																																				
<p style="font-size: 2em; font-weight: bold;">SUMMARY OF QUANTITIES</p>																																																																																																																																									
<p style="font-size: 1.5em; font-weight: bold;">REMOVE AND REMOUNT SPECIAL ROADSIDE SIGNS</p>																																																																																																																																									
<table border="1" style="width: 100%; border-collapse: collapse;"> <thead> <tr> <th colspan="3">REMOUNT UNMODIFIED HWY. SIGN SPECIAL ROADSIDE (EACH)</th> </tr> <tr> <th style="width: 70%;">STATION</th> <th style="width: 15%;">SIGN NO.</th> <th style="width: 15%;">QUANTITY</th> </tr> </thead> <tbody> <tr><td> </td><td> </td><td> </td></tr> <tr><td> </td><td> </td><td> </td></tr> <tr><td> </td><td> </td><td> </td></tr> <tr><td> </td><td> </td><td> </td></tr> <tr><td> </td><td> </td><td> </td></tr> <tr><td> </td><td> </td><td> </td></tr> <tr><td> </td><td> </td><td> </td></tr> <tr><td> </td><td> </td><td> </td></tr> <tr><td> </td><td> </td><td> </td></tr> <tr><td> </td><td> </td><td> </td></tr> <tr><td> </td><td> </td><td> </td></tr> <tr><td> </td><td> </td><td> </td></tr> <tr><td> </td><td> </td><td> </td></tr> <tr><td> </td><td> </td><td> </td></tr> <tr><td> </td><td> </td><td> </td></tr> <tr><td> </td><td> </td><td> </td></tr> <tr><td> </td><td> </td><td> </td></tr> <tr><td> </td><td> </td><td> </td></tr> <tr><td> </td><td> </td><td> </td></tr> <tr> <td colspan="2" style="text-align: right; font-weight: bold;">TOTALS</td> <td style="text-align: center;">#</td> </tr> </tbody> </table>			REMOUNT UNMODIFIED HWY. SIGN SPECIAL ROADSIDE (EACH)			STATION	SIGN NO.	QUANTITY																																																										TOTALS		#	<table border="1" style="width: 100%; border-collapse: collapse;"> <thead> <tr> <th colspan="3">REM. HIGHWAY SIGN-SPEC ROADSIDE (EACH)</th> </tr> <tr> <th style="width: 70%;">STATION</th> <th style="width: 15%;">SIGN NO.</th> <th style="width: 15%;">QUANTITY</th> </tr> </thead> <tbody> <tr><td> </td><td> </td><td> </td></tr> <tr><td> </td><td> </td><td> </td></tr> <tr><td> </td><td> </td><td> </td></tr> <tr><td> </td><td> </td><td> </td></tr> <tr><td> </td><td> </td><td> </td></tr> <tr><td> </td><td> </td><td> </td></tr> <tr><td> </td><td> </td><td> </td></tr> <tr><td> </td><td> </td><td> </td></tr> <tr><td> </td><td> </td><td> </td></tr> <tr><td> </td><td> </td><td> </td></tr> <tr><td> </td><td> </td><td> </td></tr> <tr><td> </td><td> </td><td> </td></tr> <tr><td> </td><td> </td><td> </td></tr> <tr><td> </td><td> </td><td> </td></tr> <tr><td> </td><td> </td><td> </td></tr> <tr><td> </td><td> </td><td> </td></tr> <tr><td> </td><td> </td><td> </td></tr> <tr><td> </td><td> </td><td> </td></tr> <tr><td> </td><td> </td><td> </td></tr> <tr> <td colspan="2" style="text-align: right; font-weight: bold;">TOTALS</td> <td style="text-align: center;">#</td> </tr> </tbody> </table>			REM. HIGHWAY SIGN-SPEC ROADSIDE (EACH)			STATION	SIGN NO.	QUANTITY																																																										TOTALS		#
REMOUNT UNMODIFIED HWY. SIGN SPECIAL ROADSIDE (EACH)																																																																																																																																									
STATION	SIGN NO.	QUANTITY																																																																																																																																							
TOTALS		#																																																																																																																																							
REM. HIGHWAY SIGN-SPEC ROADSIDE (EACH)																																																																																																																																									
STATION	SIGN NO.	QUANTITY																																																																																																																																							
TOTALS		#																																																																																																																																							
<p>ALL EXISTING SIGNS (INCLUDING PANEL SIGNS) TO BE REMOVED SHALL BE SALVAGED. THE CONTRACTOR SHALL BUNDLE ALL REMOVED SIGNS ON A PALLET. SIGNS OF THE SAME SIZE AND TYPE SHALL BE BUNDLED TOGETHER. THE CONTRACTOR SHALL UNLOAD THESE SIGNS TO A LOCATION TO BE DETERMINED BY THE ENGINEER. THE CONTRACTOR SHALL UNLOAD THE SIGNS. THE CONTRACTOR SHALL CONTACT THE SIGN SHOP AT (404) 444-4444 AT LEAST FIVE WORKING DAYS PRIOR TO THE REMOVAL OF THE SIGNS TO ENSURE THAT DEPARTMENT PERSONNEL WILL BE AVAILABLE TO UNLOAD THE SIGNS.</p>																																																																																																																																									
<p style="font-size: 1.5em; font-weight: bold;">GEORGIA</p> <p style="font-size: 0.8em;">DEPARTMENT OF TRANSPORTATION</p>		<table border="1" style="width: 100%; border-collapse: collapse;"> <thead> <tr> <th style="width: 15%;">REVISION DATES</th> <th style="width: 15%;"></th> <th style="width: 15%;"></th> <th style="width: 15%;"></th> <th style="width: 15%;"></th> </tr> </thead> <tbody> <tr><td> </td><td> </td><td> </td><td> </td><td> </td></tr> <tr><td> </td><td> </td><td> </td><td> </td><td> </td></tr> <tr><td> </td><td> </td><td> </td><td> </td><td> </td></tr> <tr><td> </td><td> </td><td> </td><td> </td><td> </td></tr> <tr><td> </td><td> </td><td> </td><td> </td><td> </td></tr> </tbody> </table>				REVISION DATES																																																																																																																																			
REVISION DATES																																																																																																																																									
<p>STATE OF GEORGIA DEPARTMENT OF TRANSPORTATION OFFICE:</p>		<p style="font-size: 1.2em; font-weight: bold;">SUMMARY OF QUANTITIES</p> <p>APPENDIX D-4</p>																																																																																																																																							
		<p>6-</p>																																																																																																																																							

Appendix E. General Notes

- E-1 Standard Signs General Notes
- E-2 Special Roadway and Overhead Highway Signs General Notes

PROJECT NUMBER SHEET NO. DATE PROJECT NAME

1, 2, 3, 4, 5, 6, 7, 8, 9, 10, 11, 12, 13, 14, 15, 16, 17, 18, 19, 20, 21, 22, 23, 24, 25, 26, 27, 28, 29, 30, 31, 32, 33, 34, 35, 36, 37, 38, 39, 40, 41, 42, 43, 44, 45, 46, 47, 48, 49, 50, 51, 52, 53, 54, 55, 56, 57, 58, 59, 60, 61, 62, 63, 64, 65, 66, 67, 68, 69, 70, 71, 72, 73, 74, 75, 76, 77, 78, 79, 80, 81, 82, 83, 84, 85, 86, 87, 88, 89, 90, 91, 92, 93, 94, 95, 96, 97, 98, 99, 100

GENERAL NOTES - STANDARD SIGNS

1. ALL STANDARD HIGHWAY SIGNS SHALL BE FABRICATED AND ERECTED IN ACCORDANCE WITH THE DETAILS SHOWN IN THE PLANS, THE MANUAL ON UNIFORM TRAFFIC CONTROL DEVICES, CURRENT EDITION, AND THE GEORGIA SPECIFICATIONS, SUPPLEMENTAL SPECIFICATIONS, AND/OR SPECIAL PROVISIONS.
2. SIGN ERECTION STATIONS ARE APPROXIMATE AND MAY BE ADJUSTED TO MEET FIELD CONDITIONS WHERE NECESSARY, BUT SHALL BE WITHIN THE LIMITATIONS SET FORTH IN THE MANUAL ON UNIFORM TRAFFIC CONTROL DEVICES, CURRENT EDITION. NO SIGN LOCATION SHALL BE CHANGED BY THE CONTRACTOR OR BY THE PROJECT ENGINEER WITHOUT PRIOR APPROVAL FROM THE OFFICE OF TRAFFIC OPERATIONS.
- 3a. ALL STANDARD HIGHWAY SIGNS EXCEPT AS PROVIDED FOR IN "B" SHALL BE ERECTED AT A HEIGHT OF 7 FEET ABOVE THE NORMAL EDGE OF PAVEMENT TO THE BOTTOM OF THE SIGN OR ASSEMBLY. IF SIDEWALK IS PROPOSED OR EXISTING, THE SIGNS SHALL BE ERECTED AT A HEIGHT OF 7 FEET ABOVE THE SIDEWALK.
- 3b. RS-1 "DO NOT ENTER" SIGNS ALONG FREEWAY OR INTERSTATE EXIT RAMP'S SHALL BE ERECTED AT A HEIGHT OF 3 TO 4 FEET ABOVE THE NORMAL EDGE OF PAVEMENT TO THE BOTTOM OF THE SIGN OR ASSEMBLY.
- 4a. HORIZONTAL CLEARANCE FOR STANDARD HIGHWAY SIGNS ON INTERSTATE HIGHWAYS SHALL BE 10 FEET FROM THE NORMAL EDGE OF PAVEMENT TO THE NEARER EDGE OF THE SIGN(S), UNLESS SPECIFIED OTHERWISE IN THE PLANS. HORIZONTAL CLEARANCE FOR STANDARD HIGHWAY SIGNS ON RAMP'S SHALL BE 2 FEET FROM THE NORMAL EDGE OF PAVED SHOULDER, OR EDGE OF GRADED SHOULDER WHEN PRESENT.
- 4b. HORIZONTAL CLEARANCE FOR STANDARD HIGHWAY SIGNS ON ALL OTHER ROADWAYS SHALL BE 6 FEET FROM THE EDGE OF THE PAVED SHOULDER OR 12 FEET FROM THE NORMAL EDGE OF PAVEMENT TO THE NEARER EDGE OF THE SIGN(S). HOWEVER IS GREATER. THE HORIZONTAL CLEARANCE IN NON-MOUNTABLE CURB AND CUTTER SECTIONS SHALL BE AT LEAST 2 FEET FROM THE FACE OF CURB TO THE NEARER EDGE OF THE SIGN(S). SUPPLEMENTAL OR SECONDARY SIGNS MOUNTED LESS THAN 7' ABOVE SIDEWALK SHALL NOT PROJECT MORE THAN 4 INCHES HORIZONTAL INTO THE PEDESTRIAN FACILITY. IN AREAS WITH SIDEWALK, SIGN POSTS SHALL PROVIDE A 4 FOOT MINIMUM SIDEWALK CLEAR WIDTH MEASURED FROM THE POST.
- 4c. WHEN GUARDRAIL IS PRESENT OR BEING PROPOSED, SIGNS SHALL BE POSTED AT UNDISTURBED DISTANCE BEHIND GUARDRAIL.
5. SINGLE PLATE. HORIZONTAL RECTANGULAR SIGNS OVER 48 INCHES IN WIDTH SHALL BE MOUNTED ON TWO POSTS WITH 2 INCH x 3/4 INCH x 1/2 INCH x WIDTH OF SIGN ALUMINUM OR GALVANIZED STEEL STRAPS. THE STRAPS SHALL BE FLUSH WITH THE BACK OF THE SIGN WITH ONE EACH ACROSS THE TOP AND BOTTOM OF THE SIGN. THE CENTERLINE OF EACH POST SHALL BE INSET 1/8TH OF THE SIGN WIDTH FROM THE EDGE OF THE SIGN. SIGN PLATE BOLT HOLES SHALL BE 3/8 INCH DIAMETER, DRILLED OR PUNCHED, AS SHOWN ON THE SIGN PLATE DETAILS.
6. EACH 42- OR 48- INCH WIDE x 18- OR 24- INCH HIGH SIGN REQUIRES ONE 2 INCH x 1/2 INCH x WIDTH OF SIGN ALUMINUM OR GALVANIZED STEEL STRAP LOCATED IN THE CENTER OF THE SIGN AND FLUSH WITH THE BACK OF THE SIGN.
7. SIGN ASSEMBLIES SHALL BE MOUNTED ON ALUMINUM OR GALVANIZED STEEL STRAP FRAMES. FOR DETAILS AND STRAP SPECIFICATIONS REFER TO SIGN ASSEMBLY-TYPICAL FRAMING DETAILS.
8. TYPE 9 (VERY HIGH INTENSITY) REFLECTIVE SHEETING SHALL BE USED FOR ALL STANDARD HIGHWAY SIGNS REQUIRING REFLECTORIZED BACKGROUNDS EXCEPT AS SPECIFIED BELOW OR SPECIFIED OTHERWISE IN THE PLANS. EITHER CLASS I OR CLASS 2 ADHESIVE BACKING IS PERMISSIBLE.
9. TYPE 11 (VERY HIGH INTENSITY) REFLECTIVE SHEETING SHALL BE USED FOR ALL RED SERIES SIGNS (R1-1, R1-2, R1-3P, R5-1, R5-1A, R5-1B).
10. TYPE 11 (VERY HIGH INTENSITY) FLUORESCENT YELLOW REFLECTIVE SHEETING SHALL BE USED FOR ALL WARNING SIGNS.
11. TYPE 11 (VERY HIGH INTENSITY) FLUORESCENT YELLOW GREEN REFLECTIVE SHEETING SHALL BE USED FOR SCHOOL ZONE (S1-1, S2-1, S3-1, S4-3, AND THE TOP PORTION OF THE S5-1) SIGNS. ALL REGULATORY SIGNS WITHIN THE SCHOOL ZONE SIGNING SHALL HAVE TYPE 9 (VERY HIGH INTENSITY) REFLECTIVE SHEETING.
12. A 3/8 INCH MINIMUM AIR SPACE SHALL BE REQUIRED BETWEEN ALL SIGN PLATES WITHIN AN ASSEMBLY.
13. WHERE SIGNS WITHIN AN ASSEMBLY EXTEND BELOW THE STANDARD MOUNTING HOLES ON THE POST(S), ADDITIONAL 3/8 INCH DIAMETER HOLES(S), DRILLED OR PUNCHED, SHALL BE REQUIRED TO PROPERLY MOUNT THE ASSEMBLY.
14. ALL INTERSTATE, U.S., AND GEORGIA SHIELDS REQUIRING ALT, BUS, COMM, LOOP, OR SPUR SHALL USE 4 INCH SERIES "D" LETTERS. REFER TO THE MANUAL ON UNIFORM TRAFFIC CONTROL DEVICES, CURRENT EDITION, FOR DETAILS.
15. FOR DETAILS OF SPECIAL DESIGN HIGHWAY SIGNS, SEE DETAILS OF MISCELLANEOUS SIGNS.
16. REFER TO PLAN SHEETS FOR LOCATION OF THE DISTRICT ENGINEERS OFFICE TO BE SHOWN ON ALL RS52-1 (LIMITED ACCESS) SIGNS IN THIS PROJECT. IF ANY.
17. THE CONTRACTOR WILL, AS REQUESTED BY THE DISTRICT TRAFFIC OPERATIONS ENGINEER, BE REQUIRED TO REMOVE ANY EXISTING SIGNS THAT ARE DUPLICATED OR ARE CONTRARY TO THESE SIGN PLANS.

GENERAL NOTES

REVISION NOTES



DATE
BY
APP'D
NO.
04











STATE	PROJECT NUMBER	SHEET NO.	TOTAL SHEETS
GA			
<p>GENERAL NOTES - SPECIAL ROADSIDE SIGNS</p> <p>1. SPECIAL ROADSIDE SIGNS SHALL CONFORM TO THE REQUIREMENTS SET FORTH IN THE MANUAL ON UNIFORM TRAFFIC CONTROL DEVICES, CURRENT EDITION, AND ALL SUPPLEMENTS THERETO, AS WELL AS TO THE GEORGIA STANDARD SPECIFICATIONS AND/OR SPECIAL PROVISIONS.</p> <p>2. SPECIAL ROADSIDE SIGNS SHALL BE FABRICATED USING ALUMINUM BOLTED EXTRUDED PANELS.</p> <p>3. BACKGROUND FOR SPECIAL ROADSIDE SIGNS SHALL BE STANDARD INTERSTATE GREEN, TYPE 9 (VERY HIGH INTENSITY) REFLECTIVE SHEETING UNLESS SPECIFIED OTHERWISE IN THE PLANS.</p> <p>4. LEGENDS FOR SPECIAL ROADSIDE SIGNS SHALL BE WHITE, TYPE 9 (VERY HIGH INTENSITY) REFLECTIVE SHEETING LETTERS, NUMERALS, SYMBOLS, AND BORDERS ON 0.032 INCH ALUMINUM CUTOUTS.</p> <p>5. SHIELDS SHALL BE 0.08 INCH ALUMINUM OF THE SIZE AND SHAPE SPECIFIED IN THE PLANS. U.S. AND GEORGIA SHIELD LEGENDS SHALL BE BLACK NUMERALS AND LETTERS SILK SCREENED ON WHITE, TYPE 9 (VERY HIGH INTENSITY) REFLECTIVE SHEETING BACKGROUNDS WITH NO BORDERS. INTERSTATE SHIELDS SHALL BE PER THE MANUAL ON UNIFORM TRAFFIC CONTROL DEVICES, CURRENT EDITION.</p> <p>6. FOR DETAILS OF U.S. AND INTERSTATE SHIELDS AND ARROWS, REFER TO THE MANUAL ON UNIFORM TRAFFIC CONTROL DEVICES, CURRENT EDITION.</p> <p>7. LEGENDS FOR OVERHEAD HIGHWAY SIGNS SHALL BE APPLIED TO SIGN VIA SILK SCREEN OR DIRECT APPLY RECOMMENDED BY THE MANUFACTURER, BUT SHALL CONFORM TO INTERSTATE SIGNING REQUIREMENTS.</p> <p>8. SPACING BETWEEN LETTERS OR OTHER CHARACTERS THAT IS NOT SHOWN IN THE PLANS MAY BE NECESSARY, BUT SHALL BE WITHIN THE LIMITATIONS SET FORTH IN THE MANUAL ON UNIFORM TRAFFIC CONTROL DEVICES, CURRENT EDITION. NO SIGN LOCATION SHALL BE CHANGED BY THE CONTRACTOR OR BY THE PROJECT ENGINEER WITHOUT PRIOR APPROVAL FROM THE DISTRICT OFFICE OF TRAFFIC OPERATIONS.</p> <p>9. FOR ASSEMBLY DETAILS AND ASSEMBLY COMPONENTS DETAILS ON ALUMINUM BOLTED EXTRUDED PANELS, REFER TO GEORGIA STANDARDS 9041 AND 9042.</p> <p>10. FOR DETAILS OF SPECIAL ROADSIDE SIGNS SEE DETAILS OF SPECIAL ROADSIDE SIGNS.</p> <p>11. SIGN ERECTION STATIONS ARE APPROXIMATE AND MAY BE ADJUSTED TO MEET FIELD CONDITIONS WHERE NECESSARY, BUT SHALL BE WITHIN THE LIMITATIONS SET FORTH IN THE MANUAL ON UNIFORM TRAFFIC CONTROL DEVICES, CURRENT EDITION. NO SIGN LOCATION SHALL BE CHANGED BY THE CONTRACTOR OR BY THE PROJECT ENGINEER WITHOUT PRIOR APPROVAL FROM THE DISTRICT OFFICE OF TRAFFIC OPERATIONS.</p> <p>12. HORIZONTAL CLEARANCE FOR SPECIAL ROADSIDE SIGNS SHALL BE 39 FEET FROM THE NORMAL EDGE OF PAVEMENT TO THE NEAR EDGE OF THE SIGN UNLESS SPECIFIED OTHERWISE IN THE PLANS.</p> <p>13. SPECIAL ROADSIDE SIGNS ERECTED ON STEEP CUT SLOPES SHALL HAVE A MINIMUM CLEARANCE OF 10 FEET ABOVE THE SIGN TO THE NEAR EDGE OF THE SIGN UNLESS SPECIFIED OTHERWISE IN THE PLANS.</p> <p>14. EXIT CURB SIGNS SHALL BE ERECTED WITHIN A RANGE OF 25 FEET MINIMUM TO 100 FEET MAXIMUM FROM THE PHYSICAL NOSE OF THE RAMP. A MINIMUM CLEARANCE OF 2 FEET FROM THE EDGES OF THE RAMP TO THE PAVED SHOULDERS TO THE RIGHT AND LEFT EDGES OF THE SIGN, RESPECTIVELY, SHALL BE MAINTAINED.</p> <p>15. POST LENGTHS, POST SIZES, AND FOOTING SIZES FOR SPECIAL ROADSIDE SIGNS ARE ESTIMATED ONLY. IT SHALL BE THE RESPONSIBILITY OF THE CONTRACTOR TO DETERMINE THE CORRECT LENGTHS AND SIZES NECESSARY FOR THE PROJECT. FOR DETAILS OF SPECIAL ROADSIDE SIGNS WITH BREAK-AWAY POSTS, REFER TO GEORGIA STANDARDS 9044, 9048, AND 9054C.</p> <p>16. GALVANIZED STEEL I-BEAMS SHALL HAVE ALL IDENTIFICATION NUMBERS RE-ESTABLISHED AFTER COMPLETION OF GALVANIZING.</p> <p>17. FOR BREAK-AWAY POSTS THE CONTRACT BID PRICE FOR CLASS "A" CONCRETE SHALL INCLUDE THE COST OF FURNISHING AND PLACING REINFORCEMENT STEEL AND STUB POSTS AS SHOWN IN THE FOOTING DETAILS ON GEORGIA STANDARD 9054A.</p> <p>18. THE NEAR EDGE OF SIGNS ERECTED BEHIND GUARD RAIL SHALL BE 6 FEET BEHIND THE FACE OF THE GUARD RAIL.</p> <p>19. THE CONTRACTOR SHALL ENSURE THAT ALL SPECIAL ROADSIDE SIGNS INSTALLED BY THIS PROJECT HAVE A MINIMUM SIGHT DISTANCE OF 1000 FEET, CLEARING OF OBSTACLES TO OBTAIN THE MINIMUM SIGHT DISTANCE SHALL BE IN ACCORDANCE WITH SECTION 200 OF THE GEORGIA STANDARD SPECIFICATIONS. THE COST FOR THIS WORK SHALL BE INCLUDED IN THE OVERALL PRICE BID FOR THE PROJECT.</p> <p>20. BREAK-AWAY POSTS MARKED WITH AN "M" ARE SPECIAL DESIGN. THE CONTRACTOR SHALL NOT CHANGE THESE POSTS IN ANY WAY WITHOUT APPROVAL FROM THE DISTRICT OFFICE OF TRAFFIC OPERATIONS.</p>			
<p>GENERAL NOTES - OVERHEAD HIGHWAY SIGNS</p> <p>1. OVERHEAD HIGHWAY SIGNS SHALL CONFORM TO THE REQUIREMENTS SET FORTH IN THE MANUAL ON UNIFORM TRAFFIC CONTROL DEVICES, CURRENT EDITION, AND ALL SUPPLEMENTS THERETO, AS WELL AS TO THE GEORGIA STANDARD SPECIFICATIONS AND/OR SPECIAL PROVISIONS.</p> <p>2. OVERHEAD HIGHWAY SIGNS SHALL BE FABRICATED WITH ALUMINUM BOLTED EXTRUDED PANELS.</p> <p>3. BACKGROUNDS FOR OVERHEAD HIGHWAY SIGNS SHALL BE STANDARD INTERSTATE GREEN, TYPE 9 (VERY HIGH INTENSITY) REFLECTIVE SHEETING UNLESS SPECIFIED OTHERWISE IN THE PLANS.</p> <p>4. LEGENDS FOR OVERHEAD HIGHWAY SIGNS SHALL BE WHITE, TYPE 9 (VERY HIGH INTENSITY) REFLECTIVE SHEETING LETTERS, NUMERALS, SYMBOLS, AND BORDERS ON 0.032 INCH ALUMINUM CUTOUTS.</p> <p>5. SHIELDS SHALL BE 0.08 INCH ALUMINUM OF THE SIZE AND SHAPE SPECIFIED IN THE PLANS. U.S. AND GEORGIA SHIELD LEGENDS SHALL BE BLACK NUMERALS AND LETTERS SILK SCREENED ON WHITE, TYPE 9 (VERY HIGH INTENSITY) REFLECTIVE SHEETING BACKGROUNDS WITH NO BORDERS. INTERSTATE SHIELDS SHALL BE PER THE MANUAL ON UNIFORM TRAFFIC CONTROL DEVICES, CURRENT EDITION.</p> <p>6. FOR DETAILS OF U.S. AND INTERSTATE SHIELDS AND ARROWS, REFER TO THE MANUAL ON UNIFORM TRAFFIC CONTROL DEVICES, CURRENT EDITION.</p> <p>7. LEGENDS FOR OVERHEAD HIGHWAY SIGNS SHALL BE APPLIED TO SIGN VIA SILK SCREEN OR DIRECT APPLY RECOMMENDED BY THE MANUFACTURER, BUT SHALL CONFORM TO INTERSTATE SIGNING REQUIREMENTS.</p> <p>8. SPACING BETWEEN LETTERS OR OTHER CHARACTERS THAT IS NOT SHOWN IN THE PLANS MAY BE NECESSARY, BUT SHALL CONFORM TO INTERSTATE SIGNING REQUIREMENTS.</p> <p>9. YELLOW OVERLAYS SHALL BE 0.08 INCH ALUMINUM OF THE SIZE SPECIFIED IN THE PLANS. LEGENDS SHALL BE WHITE, TYPE 9 (VERY HIGH INTENSITY) REFLECTIVE SHEETING LETTERS, NUMERALS, SYMBOLS, AND BORDERS ON 0.032 INCH ALUMINUM CUTOUTS. TYPE 11 (VERY HIGH INTENSITY) REFLECTIVE SHEETING BACKGROUNDS. SEE GENERAL NOTE NO. 4 FOR BORDER. SIGN PANELS BEHIND YELLOW OVERLAYS SHALL BE THE SAME COLOR AS THE REST OF THE SIGN.</p> <p>10. ALL OVERHEAD STRUCTURES SHALL BE DESIGNED FOR EXTERNAL ILLUMINATION, ALTHOUGH ILLUMINATION IS NOT REQUIRED ON THIS PROJECT. FOR SPECIFICATIONS ON STRUCTURAL SUPPORTS FOR OVERHEAD HIGHWAY SIGNS, SEE SECTION 639 OF THE GEORGIA STANDARD SPECIFICATIONS AND SUPPLEMENTS THERETO.</p> <p>11. STRUCTURE NUMBER SHALL BE PLACED ON OUTSIDE SHOULDER VERTICAL SUPPORT OF STRUCTURE USING DIE CUT, 6 INCH SERIES OF WHITE, TYPE 11 (ENCLOSED LENS) REFLECTIVE SHEETING CHARACTERS WITH AN ANCHOR BOLT. STRUCTURE NUMBER SHALL BE PLACED ON INSIDE SHOULDER VERTICAL SUPPORT OF STRUCTURE USING DIE CUT, 6 INCH SERIES OF WHITE, TYPE 11 (ENCLOSED LENS) REFLECTIVE SHEETING CHARACTERS WITH AN ANCHOR BOLT. STRUCTURE NUMBER SHALL BE PLACED AT THE CENTERLINE OF EACH VERTICAL SUPPORT FOR ALL OVERHEAD STRUCTURES PRIOR TO THEIR DESIGN AND FABRICATION SHALL BE THE CONTRACTOR'S.</p> <p>12. ANCHOR BOLTS SHALL MEET THE REQUIREMENTS OF ASSHTO M 314 GRADE 55.</p> <p>13. THE RESPONSIBILITY TO DETERMINE THAT THE SPAN LENGTHS SHOWN ON THE PLANS ARE CORRECT AND TO VERIFY THAT THE STRUCTURES ARE PROPERLY SUPPORTED SHALL BE THE CONTRACTOR'S. THE CONTRACTOR SHALL CALL GEORGIA 811 PRIOR TO ANY DIGGING.</p> <p>14. SHORING SHALL BE INCLUDED AT NO COST TO THE DEPARTMENT IF REQUIRED FOR FOOTING CONSTRUCTION ON SIGN PROJECTS WITH NO ROADWAY CONSTRUCTION.</p> <p>15. IT SHALL BE THE CONTRACTOR'S RESPONSIBILITY TO AVOID ANY INTERFERENCE WITH UNDERGROUND UTILITIES. ANY DAMAGE TO UTILITIES CAUSED BY THE CONTRACTOR SHALL BE REPAIRED AT THE CONTRACTOR'S EXPENSE.</p> <p>16. COST FOR ANY REQUIRED TEMPORARY EROSION CONTROL SHALL BE INCLUDED IN PRICE BID FOR SIGN STRUCTURE. ANY TREES, SHRUBS, OR FLOWERS THAT ARE DAMAGED DURING INSTALLATION OF NEW SIGN STRUCTURES SHALL BE REPLACED IN KIND AT NO ADDITIONAL COST TO THE DEPARTMENT IN ACCORDANCE WITH SECTION 702 OF THE GEORGIA STANDARD SPECIFICATIONS, EXCEPT THAT SECTION 702.17 SHALL NOT APPLY TO THIS PROJECT.</p> <p>17. CONTRACTOR SHALL ENSURE THAT ALL OVERHEAD SIGNS INSTALLED BY THIS PROJECT HAVE MINIMUM SIGHT DISTANCE OF 1000 FEET. CLEARING OF OBSTACLES TO OBTAIN THE MINIMUM SIGHT DISTANCE SHALL BE IN ACCORDANCE WITH SECTION 200 OF THE GEORGIA STANDARD SPECIFICATIONS. THE COST FOR THIS WORK SHALL BE INCLUDED IN THE OVERALL PRICE BID FOR THE PROJECT.</p>			

- NO SCALE -	DATE REVISIONS STATE OF GEORGIA DEPARTMENT OF TRANSPORTATION OFFICE: TRAFFIC OPERATIONS SIGNING AND MARKING PLANS OVERHEAD / SPECIAL SIGNS GENERAL NOTES JANUARY 2008 DRAWING NO. 4
--------------	--

Intentionally Left Blank

Appendix F. Figures

Figure 3-1	State Line Signing Sequence (Non-Limited Access)
Figure 3-2	Route Signing for Turning Route
Figure 3-3	Route Signing at “T” Intersection
Figure 3-4	Route Signing at Crossing Routes
Figure 3-9	Overhead Signing
Figure 3-10	Required Signs at “T” Intersections and Road Ends
Figure 4-1	Normal Exit Sign Sequence
Figure 4-2	Post Interchange Sign Sequence
Figure 4-3	Political Boundary Signing
Figure 4-4	All Thru Trucks Sign Details
Figure 4-5	Details of Regulatory Signs
Figure 4-6	Details of Regulatory Signs
Figure 4-7	Details of Regulatory Signs
Figure 4-8	Detail of Overhead Regulatory Signs
Figure 5-1L	Lane Reduction Signing
Figure 5-1R	Lane Reduction Signing
Figure 5-2	Lane Drop Signing (Continuous Lane)
Figure 5-3	Lane Drop Signing (Auxiliary Lane)
Figure 5-4	Lane Drop Signing (Drop Option)
Figure 6-1	Details of Warning Signs
Figure 9-1	Overhead Sign Structure Numbering
Figure 10-1	Clearance Diagram - Type I
Figure 10-2	Clearance Diagram - Type III
Figure 10-3	Clearance Diagram - Type I Median
Figure 10-4	Clearance Diagram - Type VII

	SPECIAL DESIGN	2 LANE	36' x 36'
		4 LANE, 5 LANE, 4 LANE DIVIDED	36' x 36'
	SPECIAL DESIGN	2 LANE	48' x 72'
		4 LANE, 5 LANE, 4 LANE DIVIDED	48' x 72'
	M3-1, 2, 3, OR 4	SEE MUTCD FOR SIGN DIMENSIONS	
	MI-4 OR MI-5	SEE MUTCD FOR SIGN DIMENSIONS	
	R2-1	SEE MUTCD FOR SIGN DIMENSIONS	
	R550-1	2 LANE, 5 LANE	36' x 30'
		4 LANE, 4 LANE DIVIDED	36' x 30'
	R553-1	2 LANE, 5 LANE	30' x 24'
		4 LANE, 4 LANE DIVIDED	48' x 36'
	R560-1	2 LANE, 5 LANE	36' x 30'
		4 LANE, 4 LANE DIVIDED	36' x 30'
	R554-1	2 LANE, 5 LANE	30' x 24'
		4 LANE, 4 LANE DIVIDED	48' x 36'
	R560-2	2 LANE, 5 LANE	36' x 30'
		4 LANE, 4 LANE DIVIDED	36' x 30'
<p>NOTES:</p> <ol style="list-style-type: none"> 1. INSTALL SIGNS ON ALL ROUTES ENTERING THE STATE. IF THERE IS INSUFFICIENT SPACE FOR ALL SIGNS, THE ORDER OF PREFERENCE IS FROM TOP TO BOTTOM OF THIS CHART. 2. R550-1 SIGNS ARE INSTALLED ONLY IN COUNTIES THAT HAVE PERMITS TO OPERATE DETECTION DEVICES. 			
STATE LINE SIGNING SEQUENCE (NON-LIMITED ACCESS)			FIGURE 3-1

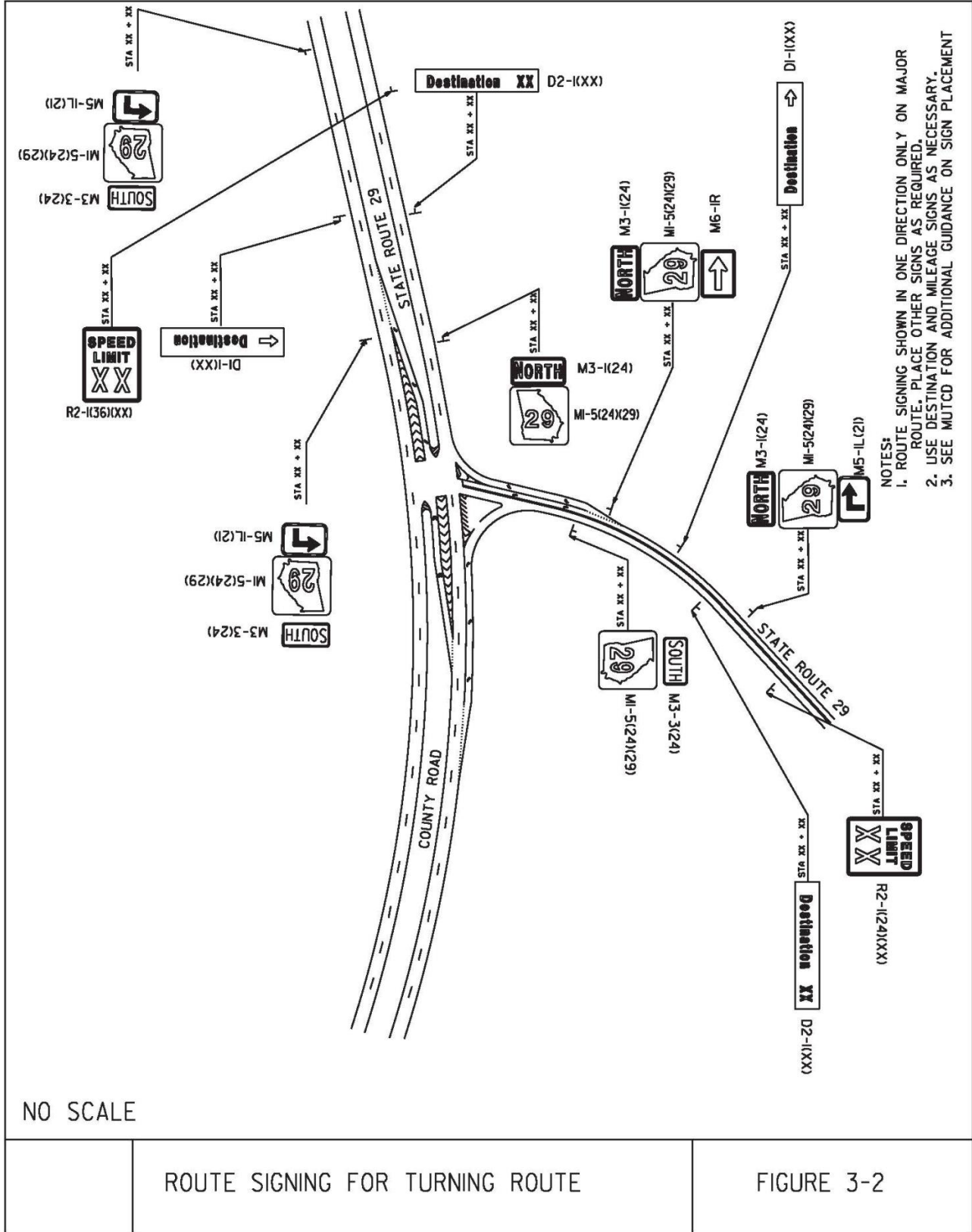

ROUTE SIGNING FOR TURNING ROUTE

FIGURE 3-2

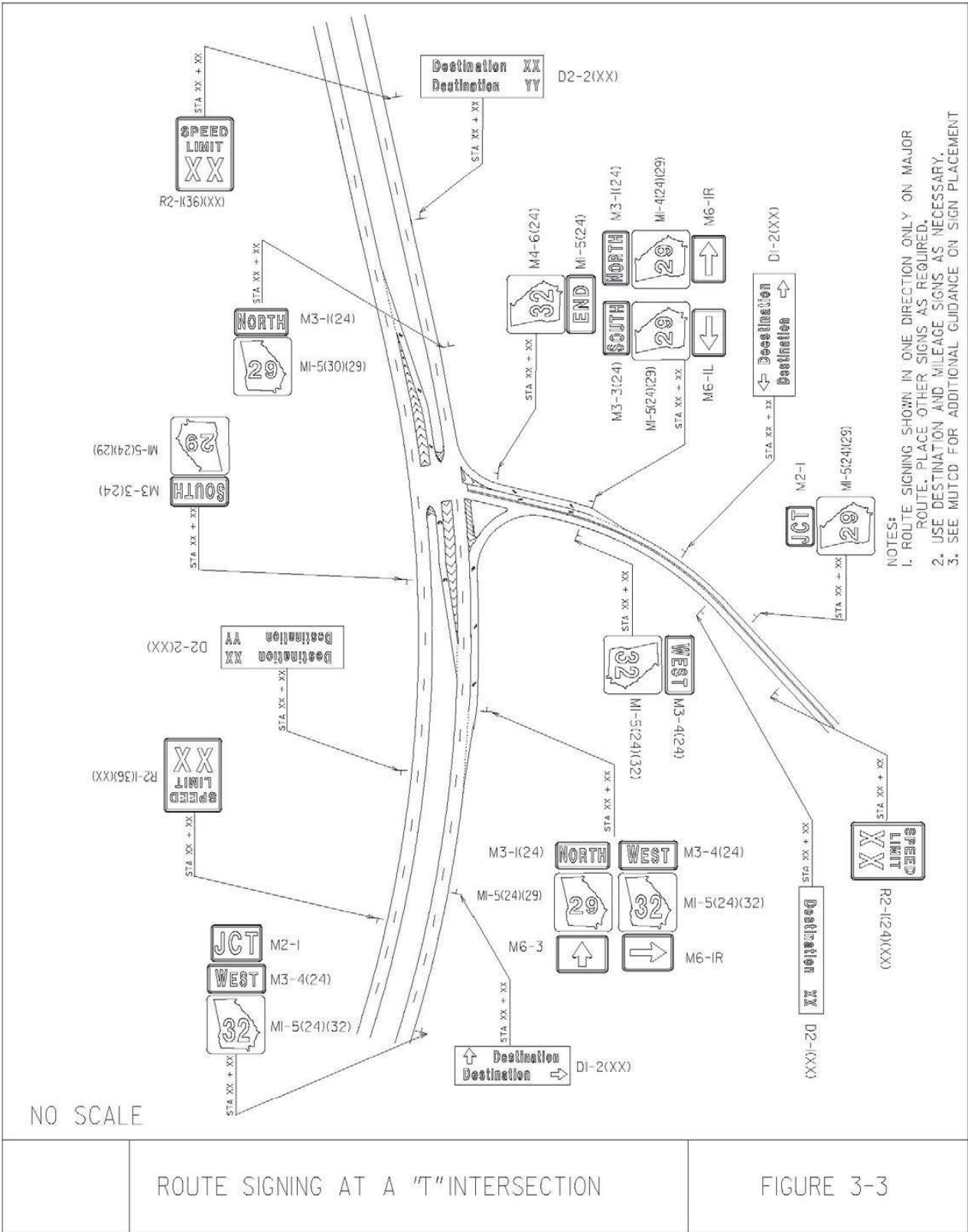

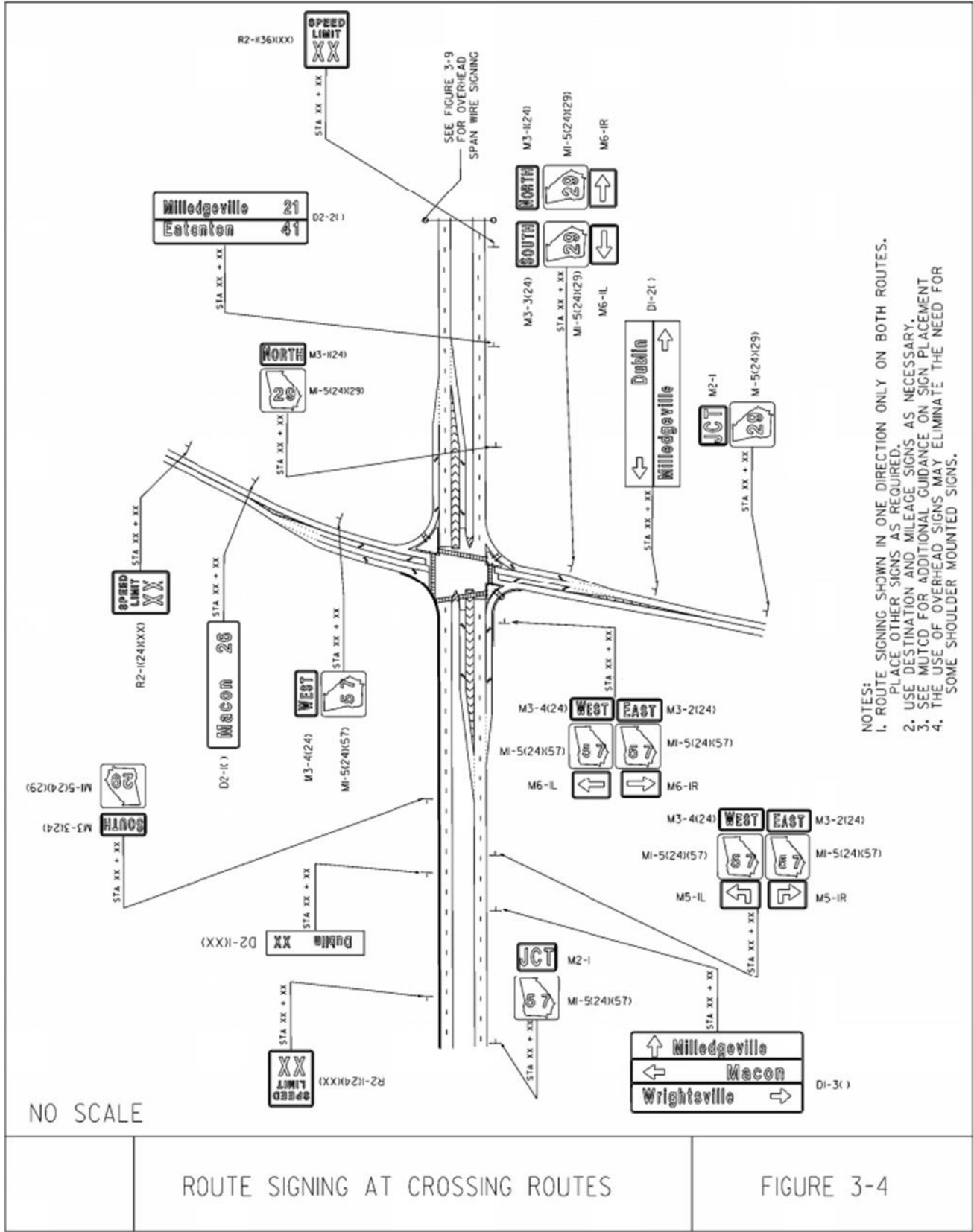

- NOTES:
1. ROUTE SIGNING SHOWN IN ONE DIRECTION ONLY ON BOTH ROUTES.
 2. PLACE OTHER SIGNS AS REQUIRED.
 3. USE DESTINATION AND MILEAGE SIGNS, AS NECESSARY.
 4. SEE MUTCD FOR ADDITIONAL GUIDANCE ON SIGN PLACEMENT
 5. THE USE OF OVERHEAD SIGNS MAY ELIMINATE THE NEED FOR SOME SHOULDER MOUNTED SIGNS.

ROUTE SIGNING AT CROSSING ROUTES

FIGURE 3-4

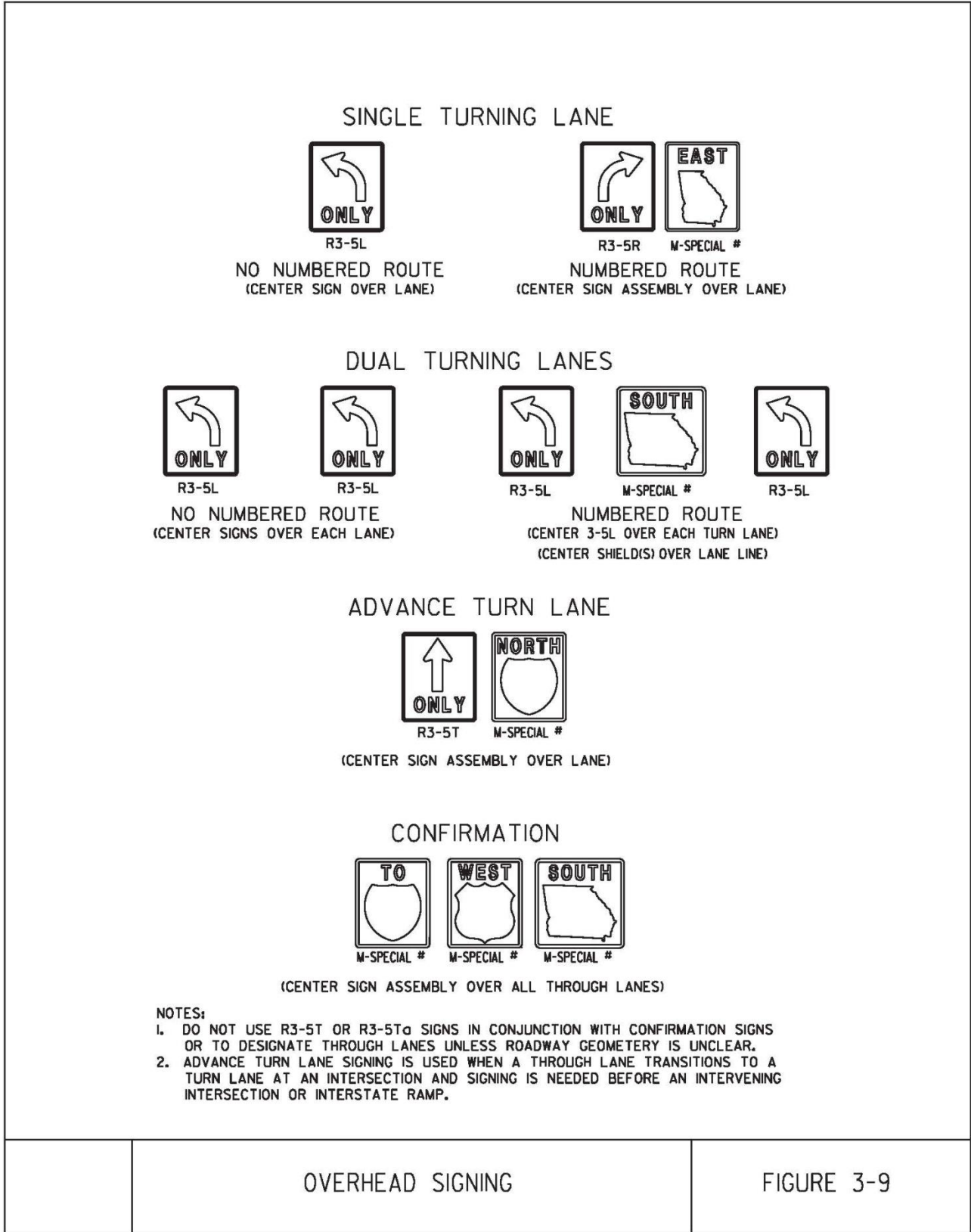

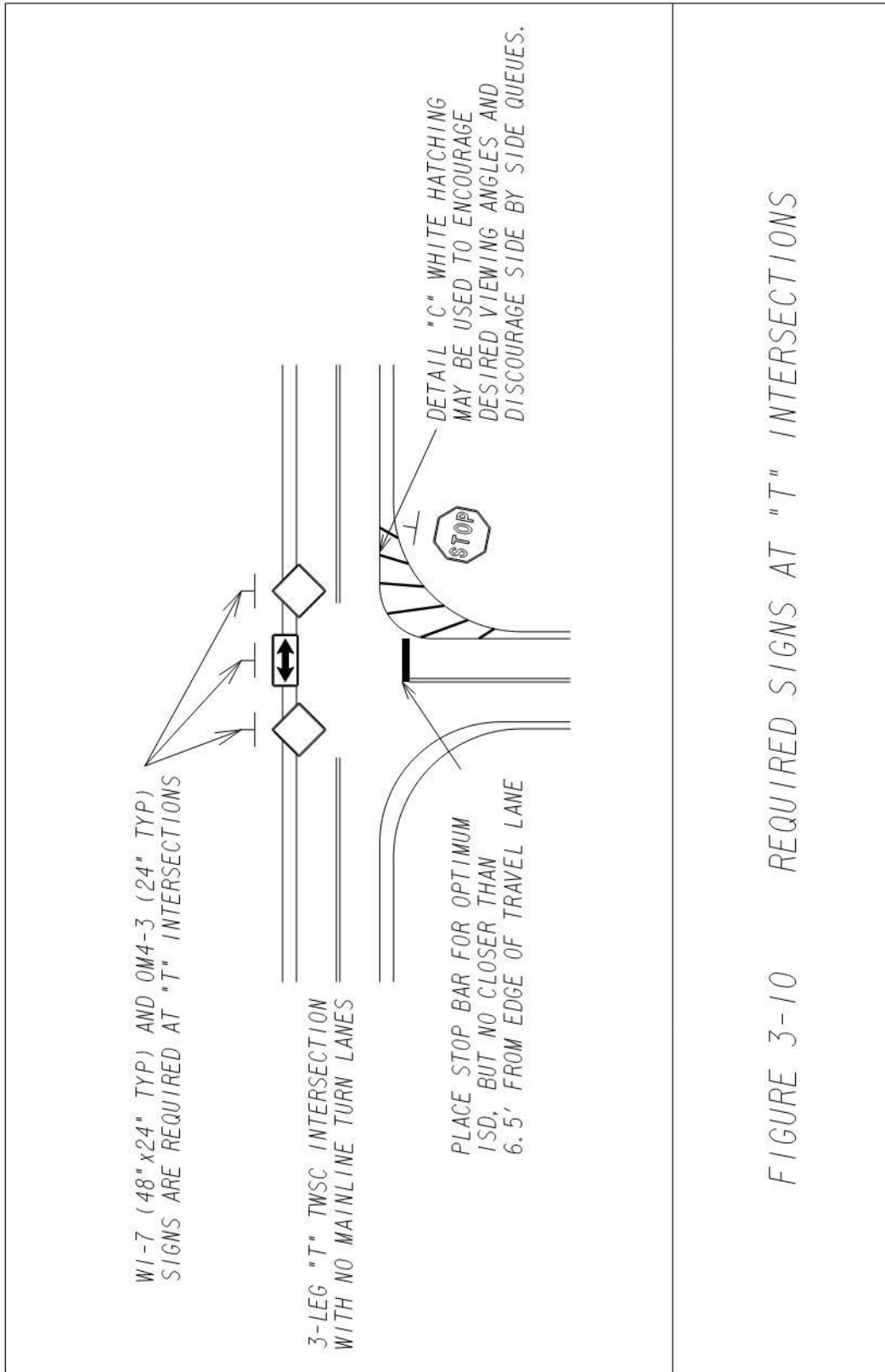

FIGURE 3-10 REQUIRED SIGNS AT "T" INTERSECTIONS

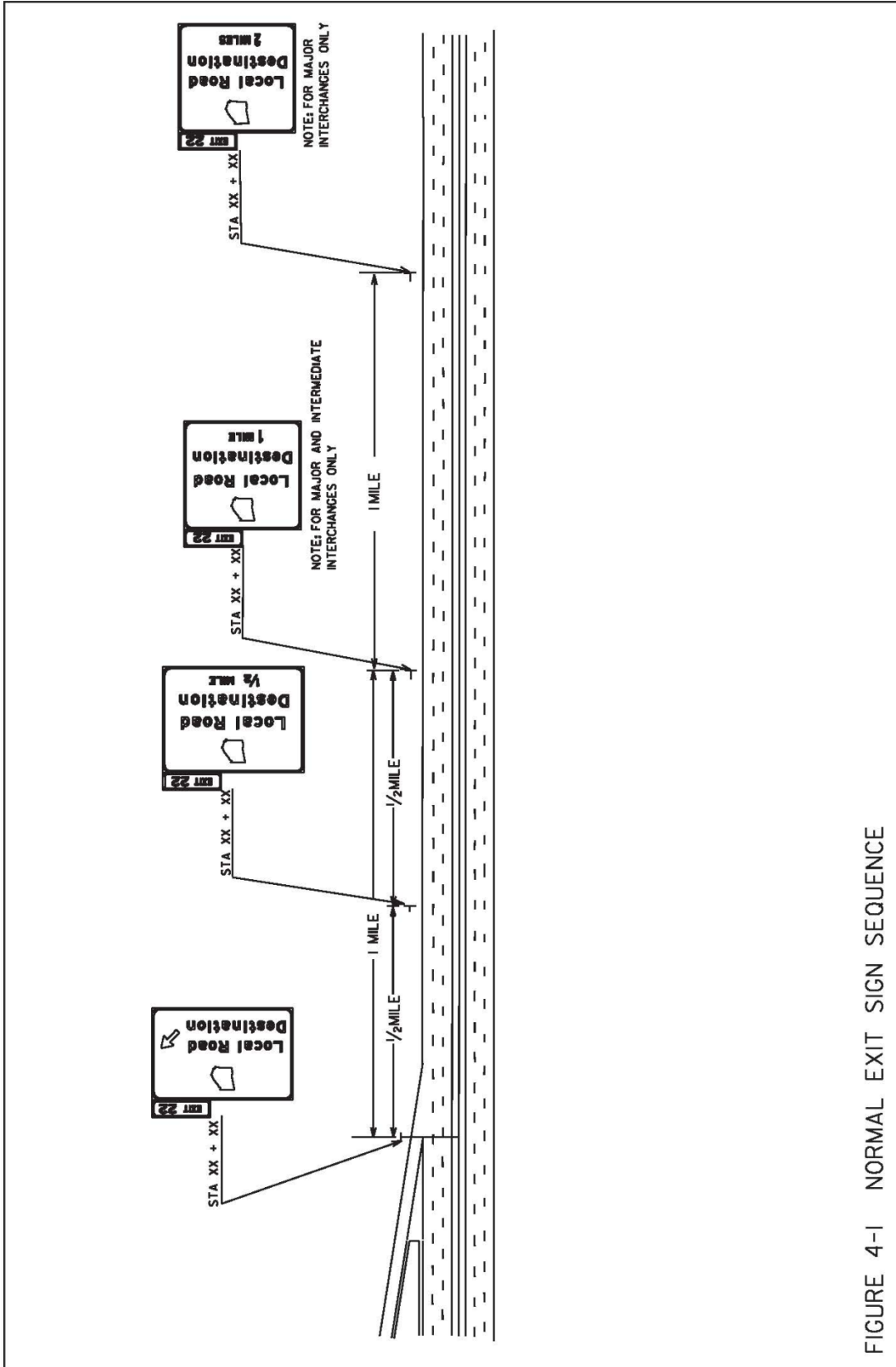

FIGURE 4-1 NORMAL EXIT SIGN SEQUENCE

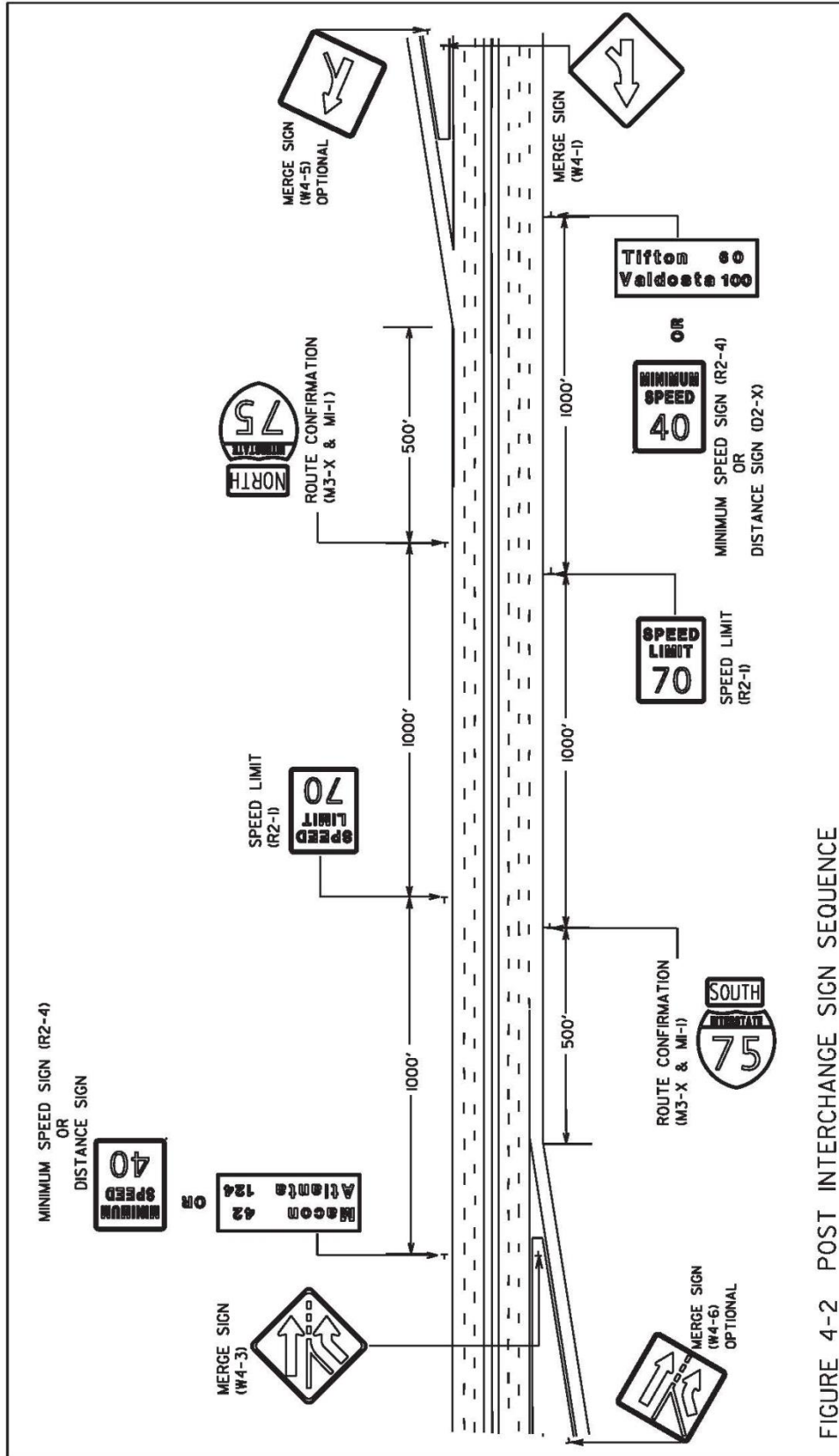
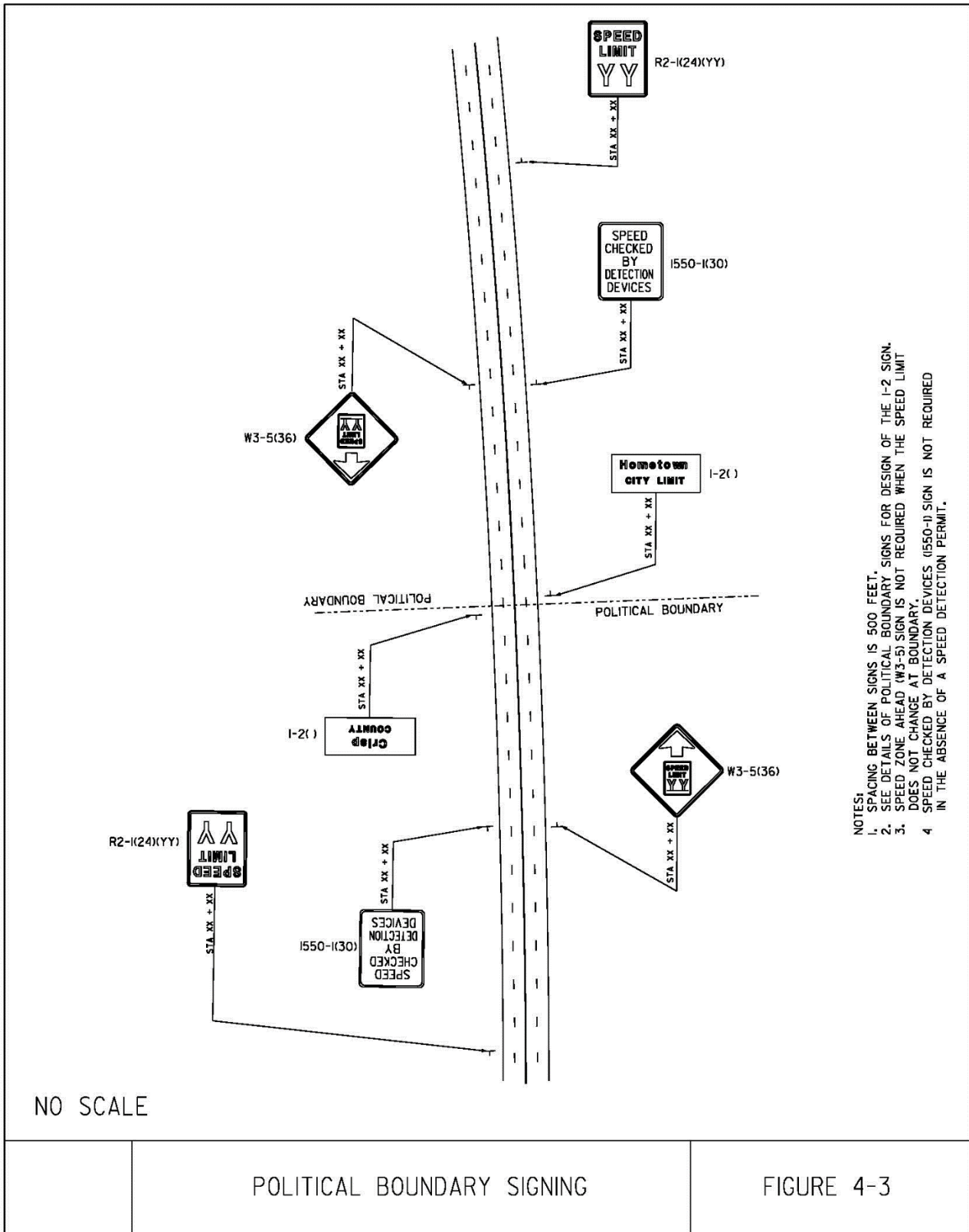
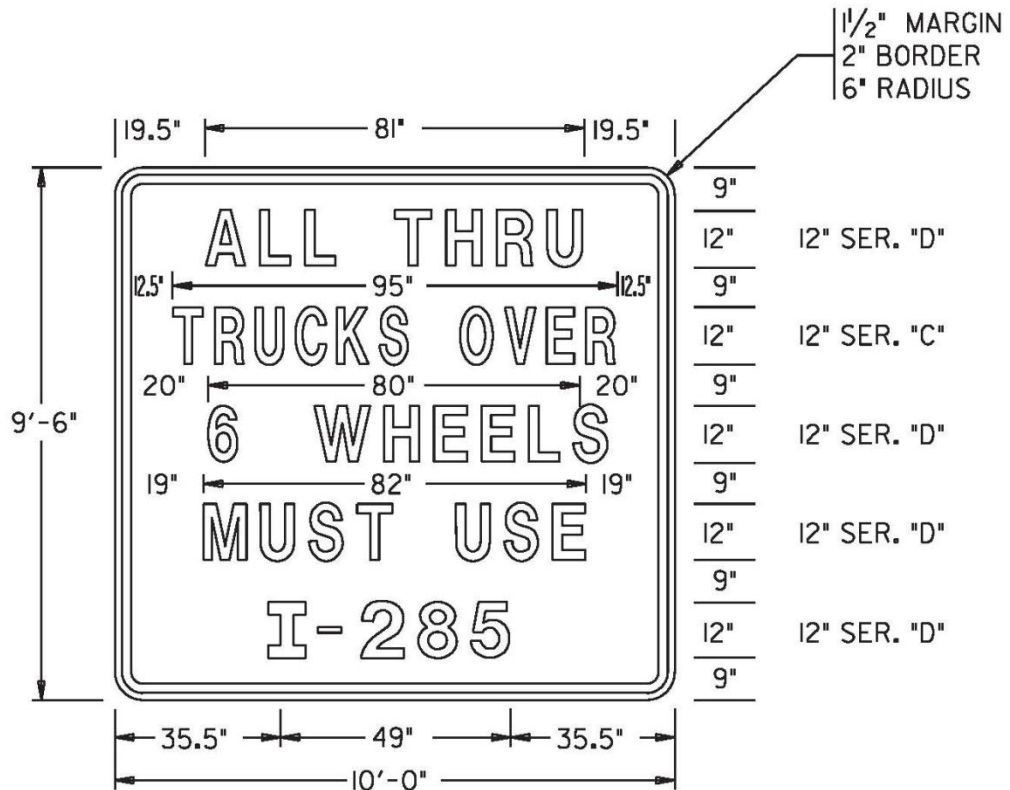

FIGURE 4-2 POST INTERCHANGE SIGN SEQUENCE



- NOTES:
1. SPACING BETWEEN SIGNS IS 500 FEET.
 2. SEE DETAILS OF POLITICAL BOUNDARY SIGNS FOR DESIGN OF THE I-2 SIGN.
 3. SPEED ZONE AHEAD (W3-5) SIGN IS NOT REQUIRED WHEN THE SPEED LIMIT DOES NOT CHANGE AT BOUNDARY.
 4. SPEED CHECKED BY DETECTION DEVICES (I550-I) SIGN IS NOT REQUIRED IN THE ABSENCE OF A SPEED DETECTION PERMIT.



R554-II

SIGN SHALL HAVE WHITE REFLECTORIZED BACKGROUND WITH BLACK LEGEND AND BORDER.

FIGURE 4-4 ALL THRU TRUCKS SIGN DETAILS

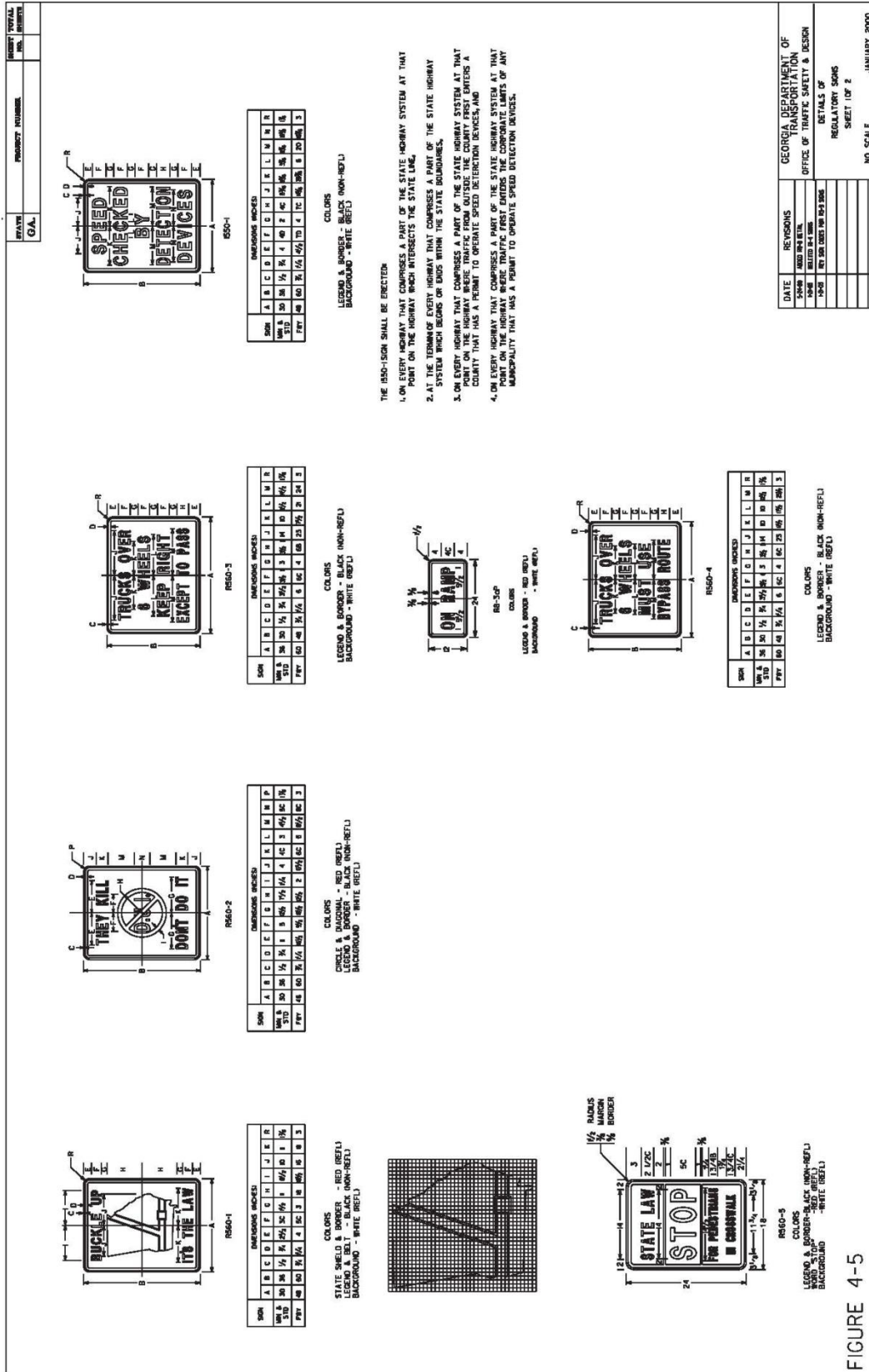
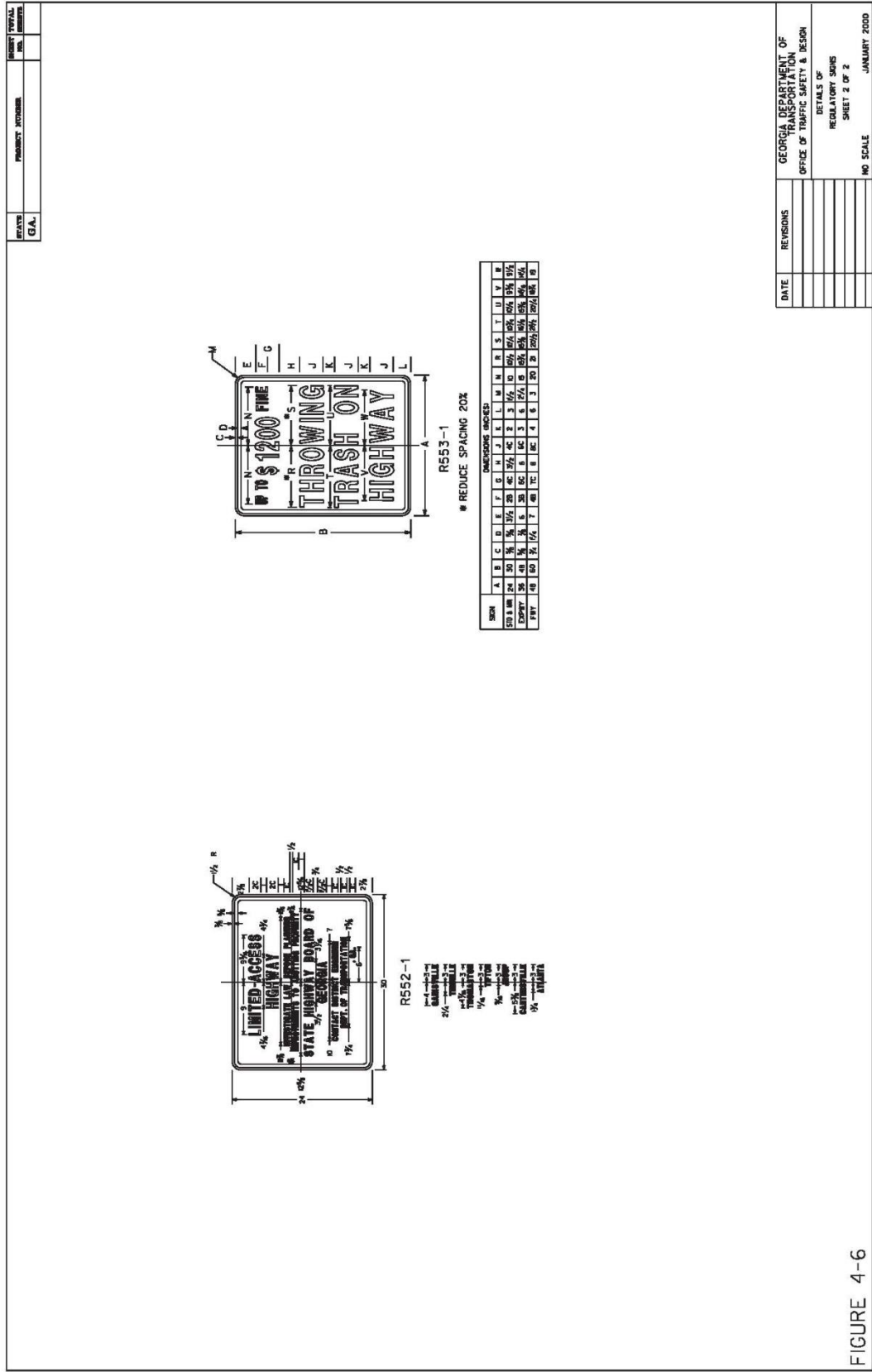
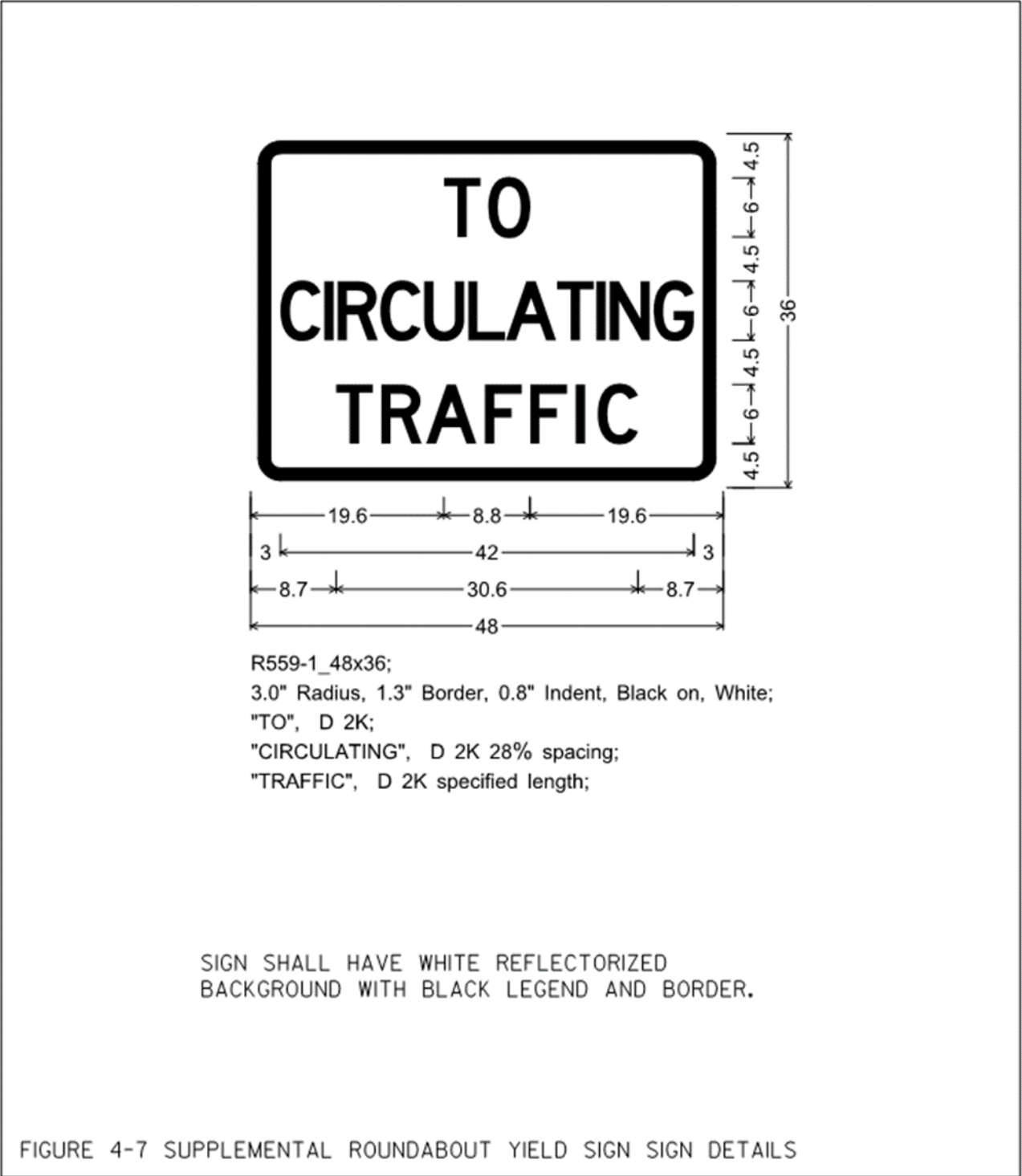

FIGURE 4-5



GEORGIA DEPARTMENT OF TRANSPORTATION
 OFFICE OF TRAFFIC SAFETY & DESIGN
 REGULATORY SERIES
 SHEET 2 OF 2
 JANUARY 2000
 MO SCALE

FIGURE 4-6



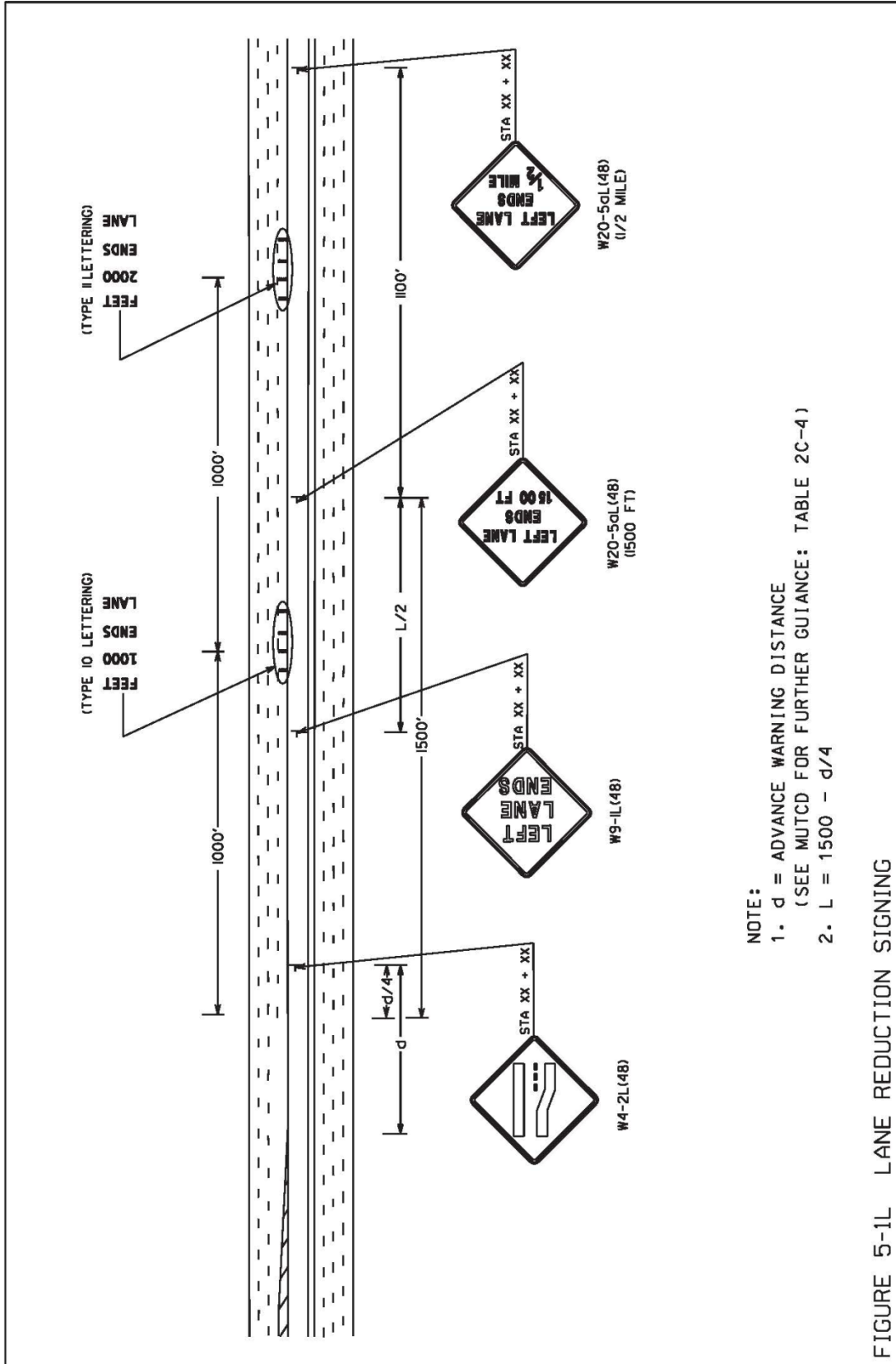
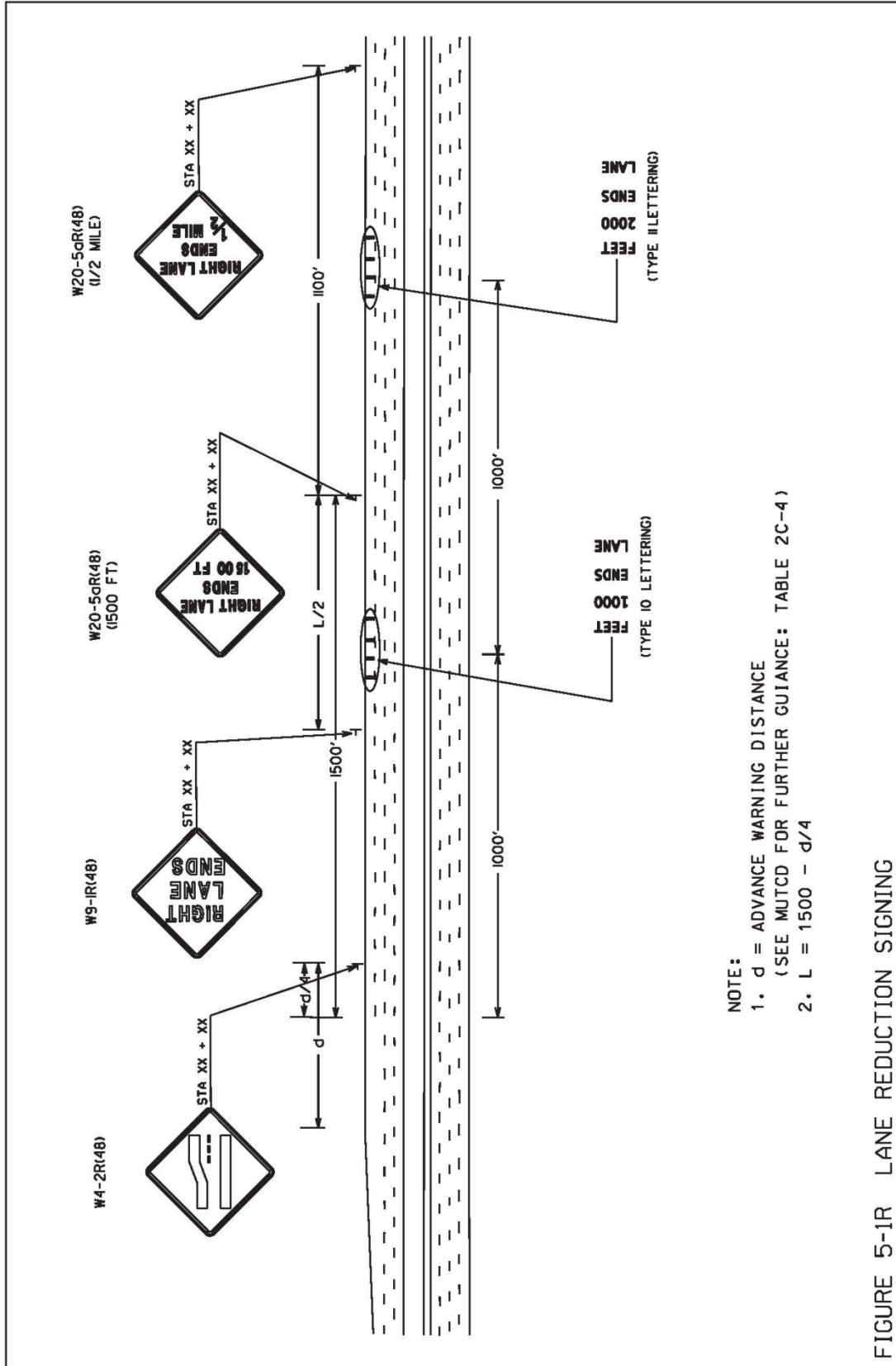

FIGURE 5-1L LANE REDUCTION SIGNING



NOTE:
 1. d = ADVANCE WARNING DISTANCE
 (SEE MUTCD FOR FURTHER GUIDANCE: TABLE 2C-4)
 2. L = 1500 - $d/4$

FIGURE 5-1R LANE REDUCTION SIGNING

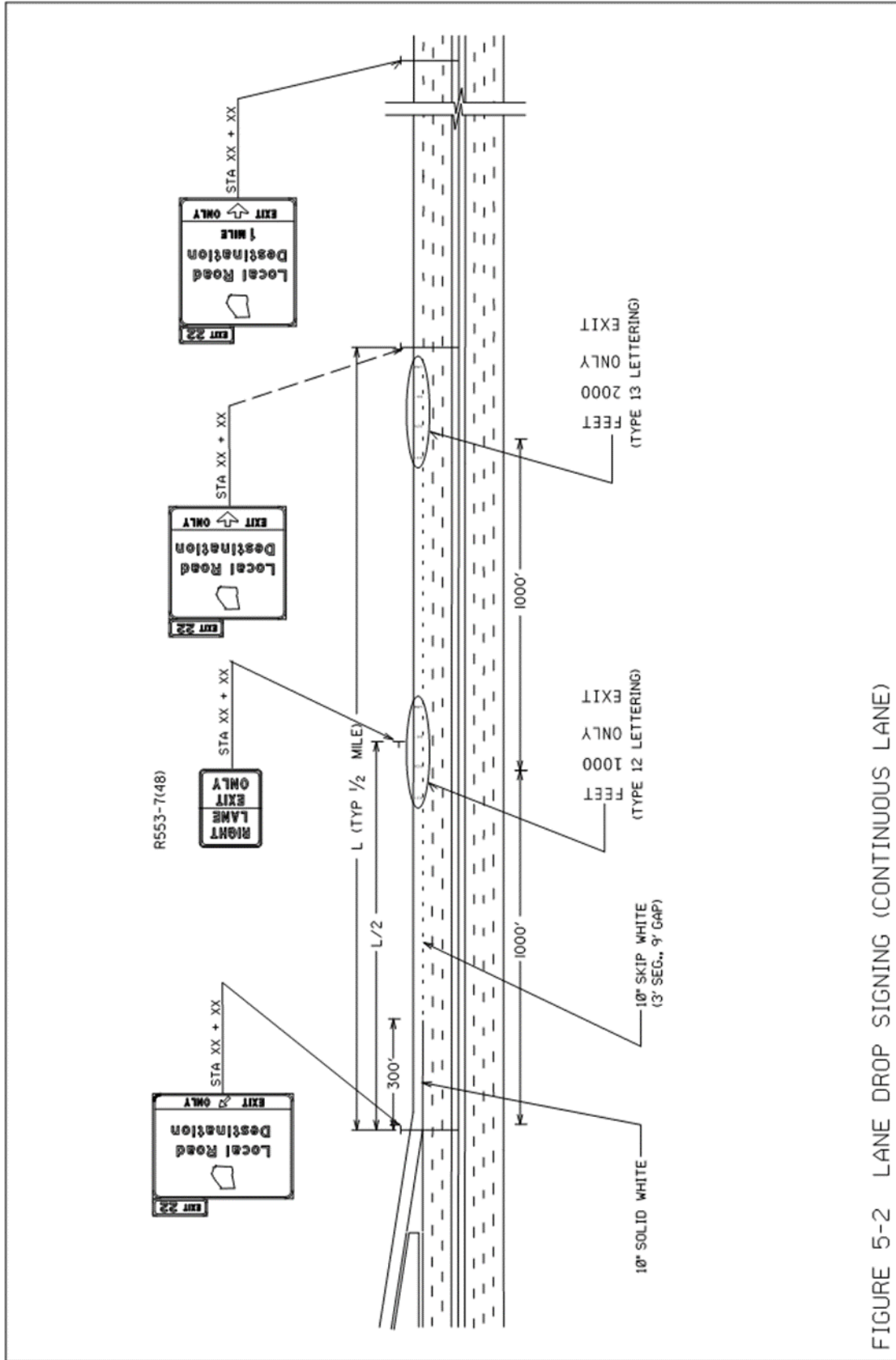

FIGURE 5-2 LANE DROP SIGNING (CONTINUOUS LANE)

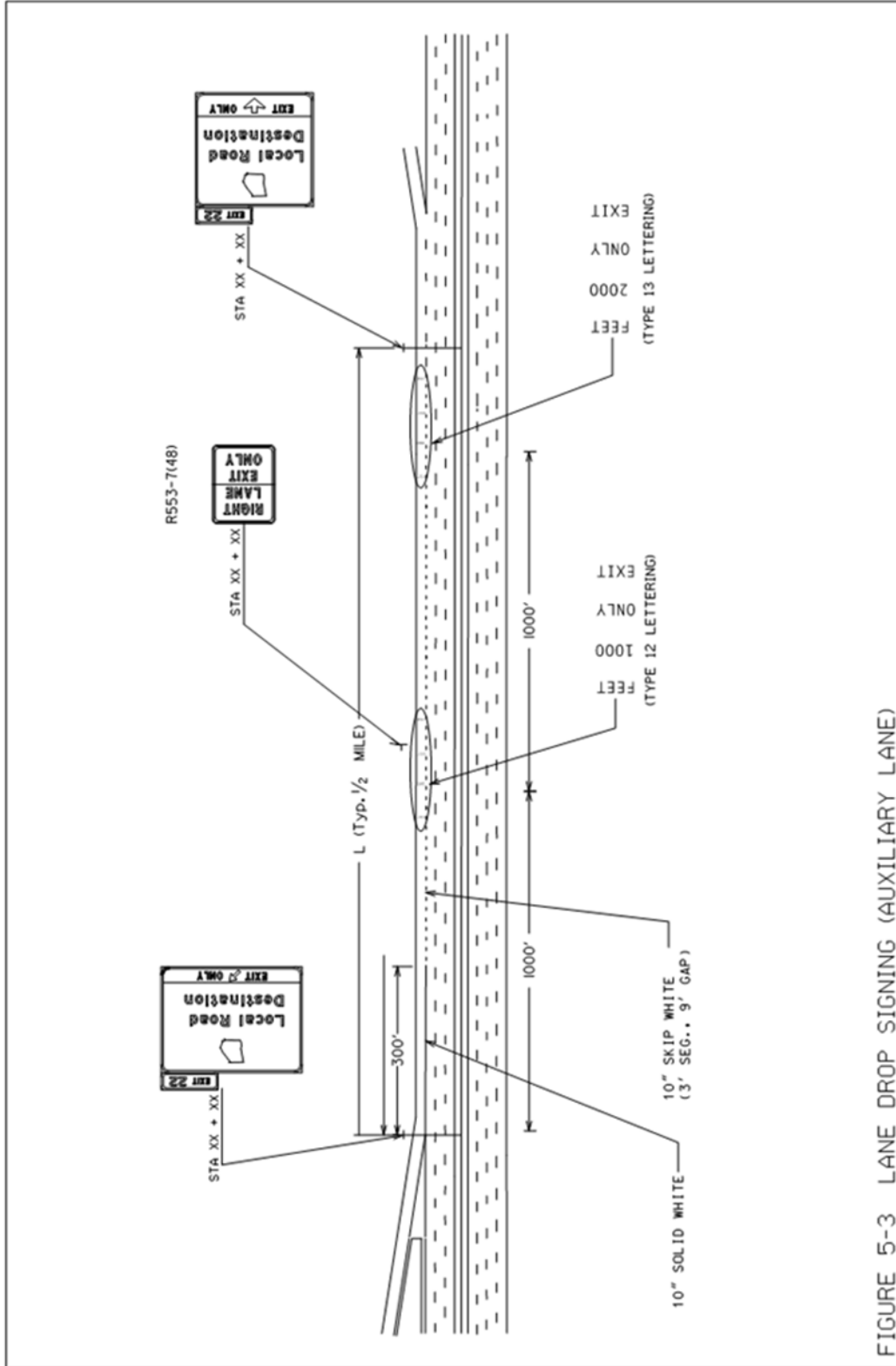

FIGURE 5-3 LANE DROP SIGNING (AUXILIARY LANE)

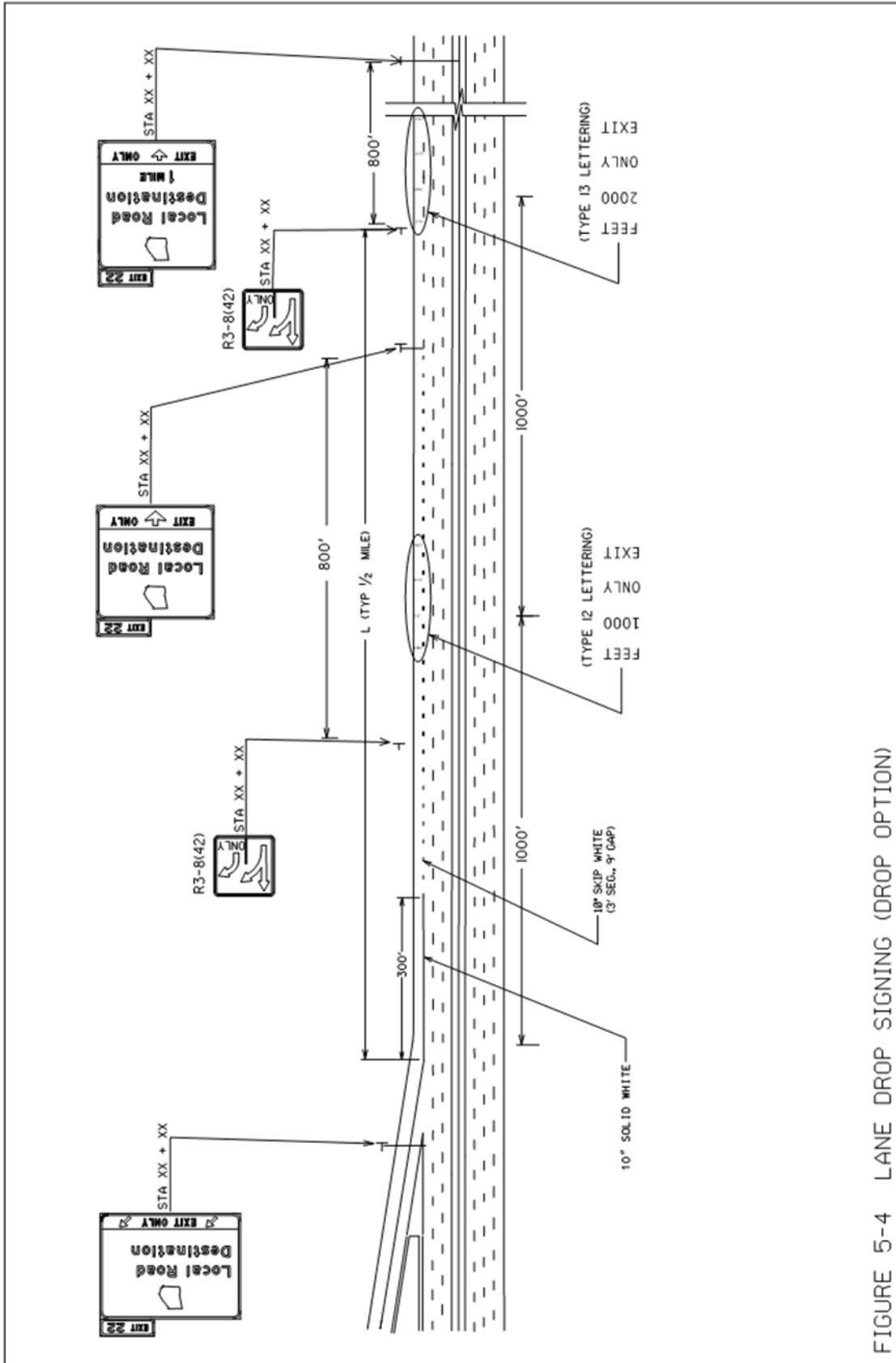
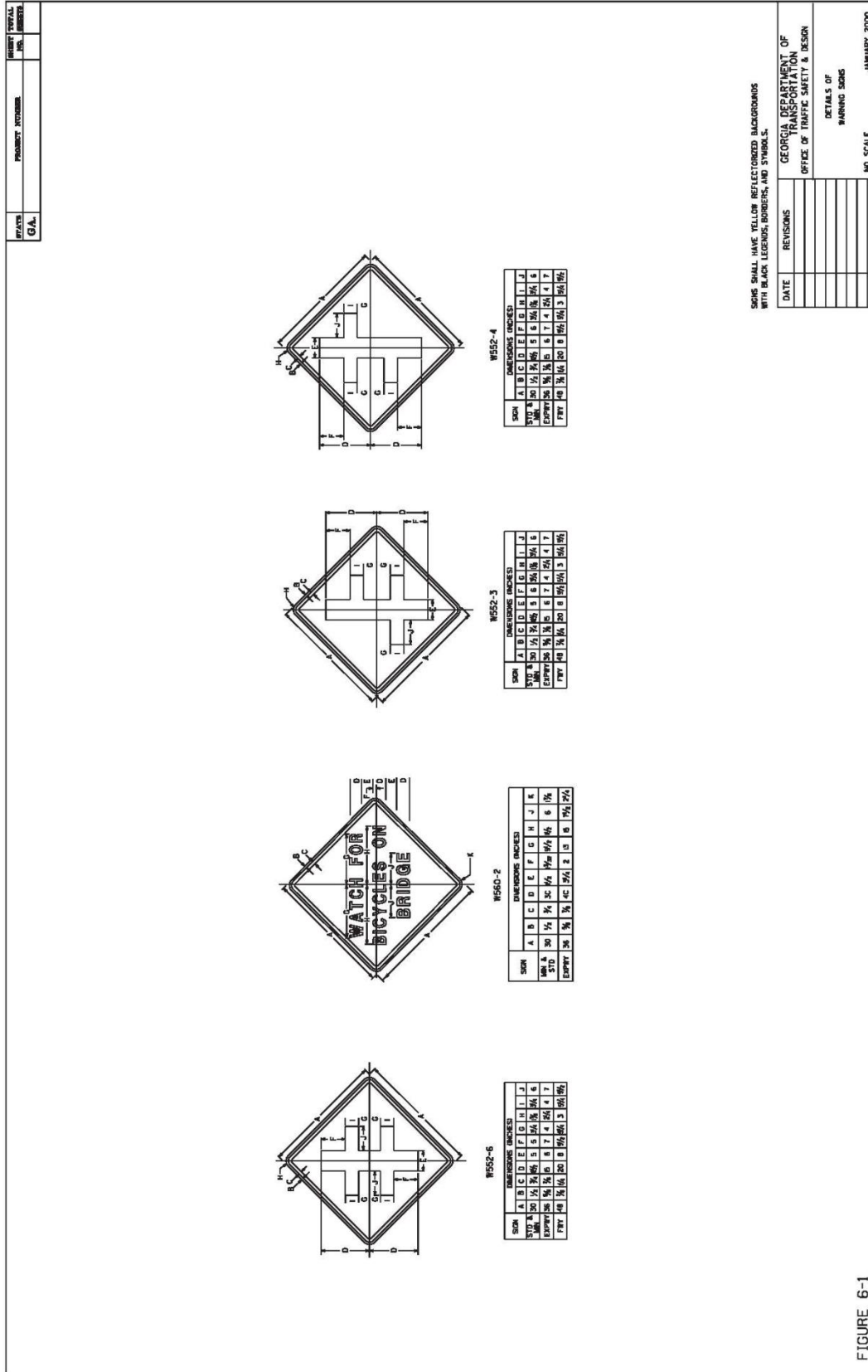

FIGURE 5-4 LANE DROP SIGNING (DROP OPTION)



Overhead sign structures will be numbered with a letter (from the list below) and 3 or 4 digits. The digits will be determined by the mainline mile post to the nearest tenth of a mile. Structures on ramps will include an “R” between the appropriate route letter and mainline mile post to the nearest tenth of a mile.

Figure 9-1: Overhead Sign Structure Numbering

A	I-20 EAST	AA	I-185 NORTH	AAA	US 411 NORTH
B	I-20 WEST	BB	I-185 SOUTH	BBB	US 411 SOUTH
C	I-75 NORTH	CC	I-675 NORTH		
D	I-75 SOUTH	DD	I-675 SOUTH		
E	I-85 NORTH	EE	SR 985 NORTH		
F	I-85 SOUTH	FF	SR 985 SOUTH		
G	I-285 CLOCKWISE	GG	I-95 NORTH		
H	I-285 C-CLOCKWISE	HH	I-95 SOUTH		
I	NOT USED				
J	SR 400 NORTH	JJ	I-16 EAST		
K	SR 400 SOUTH	KK	I-16 WEST		
L	SR 166 EAST	LL	I-516 EAST		
M	SR 166 WEST	MM	I-516 WEST		
N	SR 410 EAST	NN	I-520 SOUTH/EAST		
O	NOT USED				
P	SR 410 WEST	PP	I-520 NORTH/WEST		
Q	NOT USED				
R	RAMP				
S	I-575 NORTH	SS	SR 10 CLOCKWISE		
T	I-575 SOUTH	TT	SR 10 C-CLOCKWISE		
U	SR 5 CONN. NORTH				
V	SR 5 CONN. SOUTH	VV	SR 316 EAST		
W	SR 13 NORTH	WW	SR 316 WEST		
X	SR 13 SOUTH	XX	I-24 EAST		
Y	AIRPORT	YY	I-24 WEST		
Z	AIRPORT	Z	I-59 NORTH		

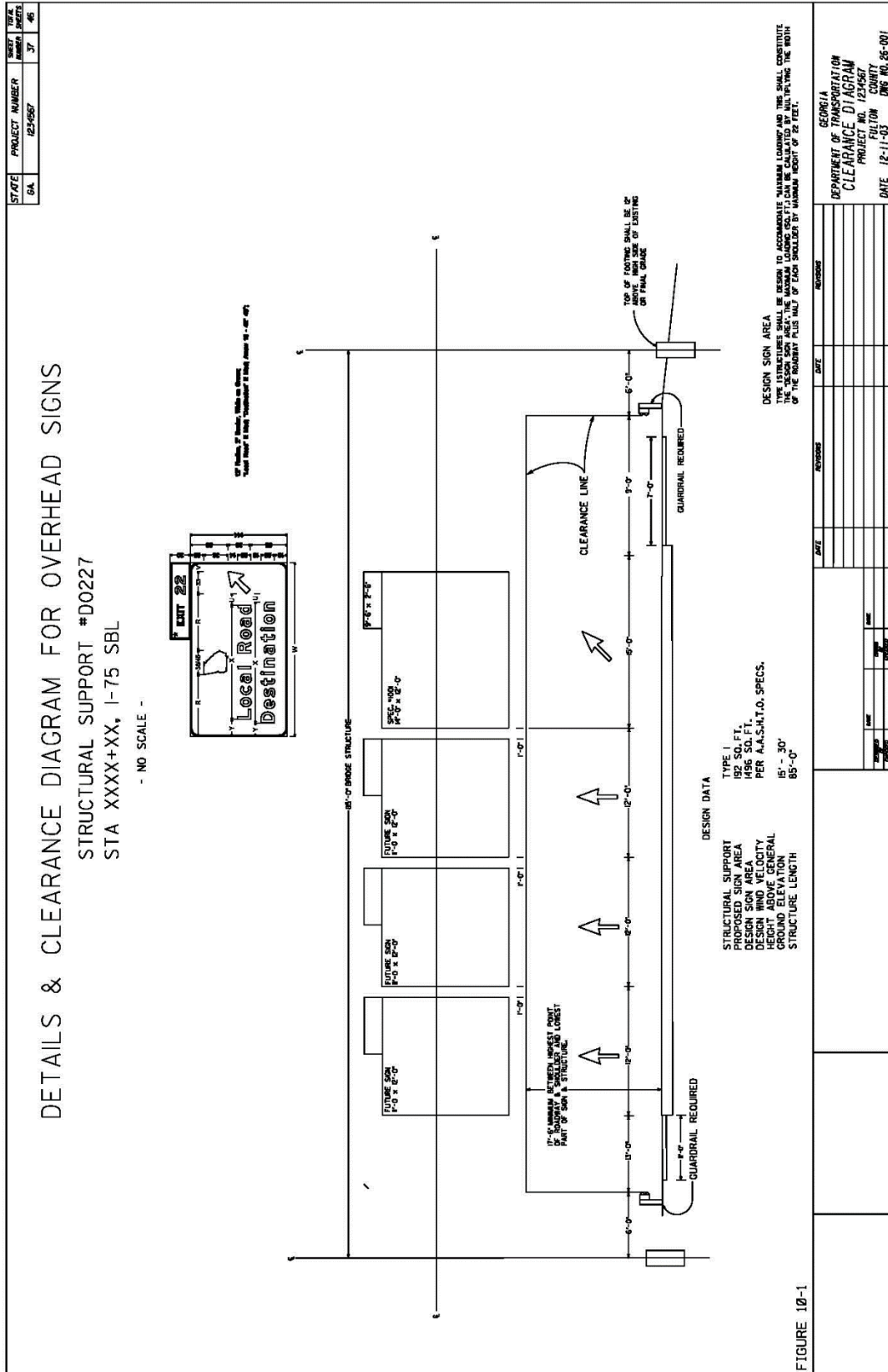

STATE	PROJECT NUMBER	DATE	NO. SHEETS	TOTAL SHEETS
GA	1234567		30	56

DETAILS & CLEARANCE DIAGRAM FOR OVERHEAD SIGNS

STRUCTURAL SUPPORT #B0192
STA XXXX+XX, I-20 WBL

- NO SCALE -

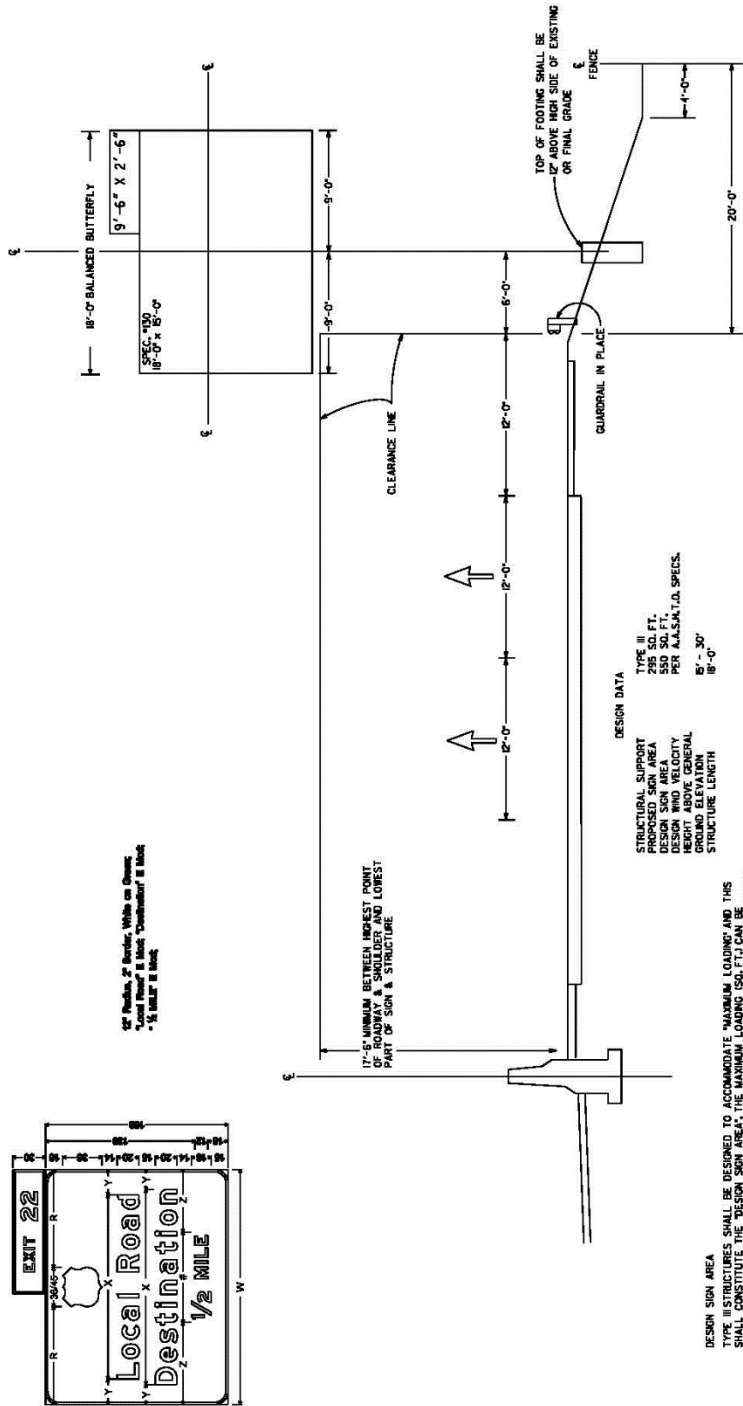

FIGURE 10-2

DATE	REVISION	DATE	REVISION	DATE	REVISION

PROJECT NO.	COUNTY	DATE
PROJECT NO.	COUNTY	DATE

GEORGIA
DEPARTMENT OF TRANSPORTATION
CLEARANCE DIAGRAM
PROJECT NO. PROJECT# COUNTY
DATE ##-##-## Dwg No. 25-25

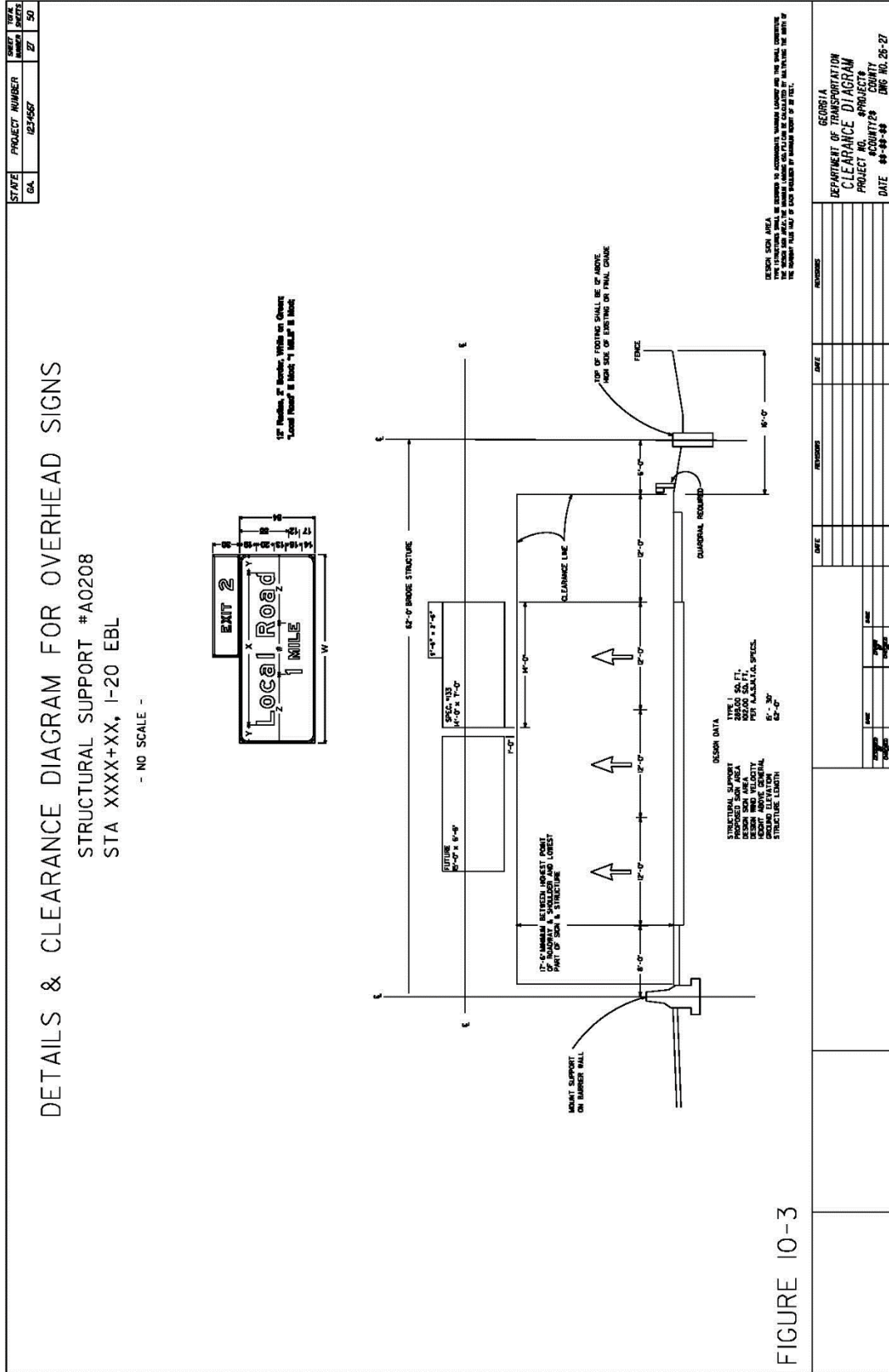

FIGURE 10-3

